

78.70

48.00

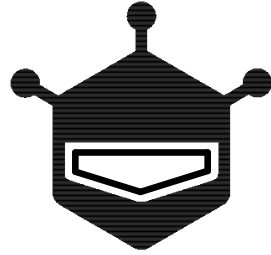

DFROBOT

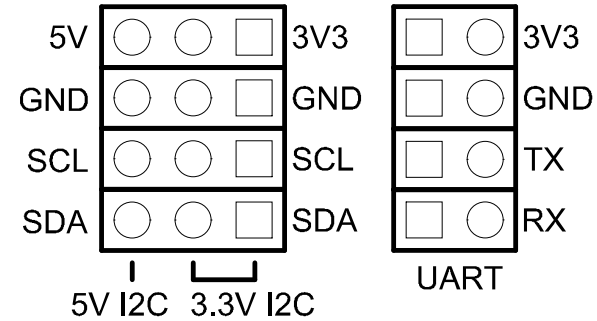
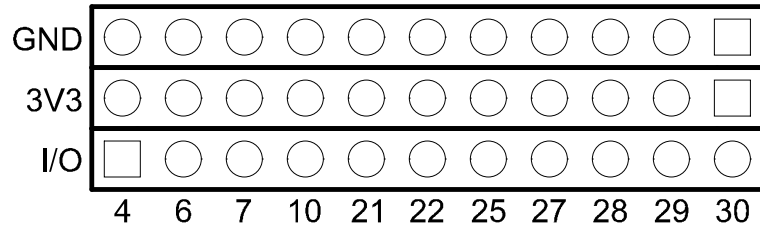
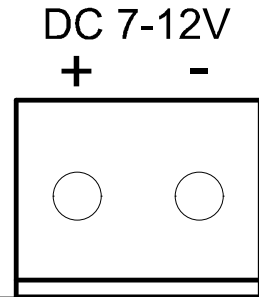
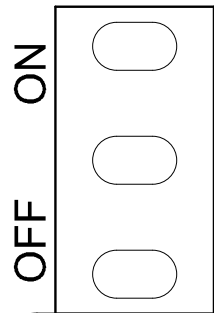

OKO PWR

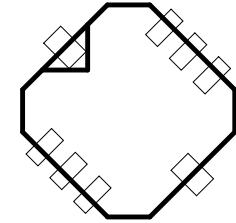
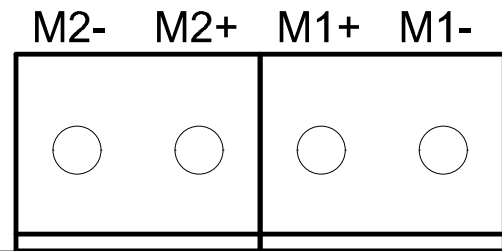

PCB Information	Name:[DFR0644](V1.0.0)	Thickness: 1.6mm
Engineer:Aaron	Top SolderMask: Black	Bottom SolderMask: Black
Date: 20220304	Top Silkscreen: White	Bottom Silkscreen: White