

1	EXTRSTN	IOA12/RX0/EINT12/SEG71	48	RX
2	IOF4/ADC_CH7/SEG63	IOB3/TX1/ISO7816_CLK0/SEG72	47	TX
3	IOE5/VDCIN/ADC_CH8/SEG62	IOA13/RX1/ISO7816_I00/EINT13/SEG73	46	LED1
4	IOE8/CMP1_P/SEG59	IOD0/COM0	45	LED2
5	IOE9/CMP1_N/SEG58	IOD1/COM1	44	LED3
6	X32KO	IOD2/COM2	43	LED4
7	X32KI	IOD3/COM3	42	LED5
8	VDD	IOD4/COM4/SEG1	41	LED6
9	AVSS	IOD5/COM5/SEG1	40	LED7
10	DVCC	IOD6/COM6/SEG2	39	LED8
11	IOE13/SEG55	IOD7/COM7/SEG3	38	LED9
12	IOA0/SWCK/EINT0/SEG54	IOD12/SEG8	37	LED10
13	IOA1/SWIO/EINT1/SEG53	IOB4/TX2/SEG12	36	LED11
14	MODE	IOA14/RX2/EINT14/SEG13	35	LED12
A	IOA3/RTC_PLLDIV/EINT3/SEG51	IOB5/TX3/ISO7816_CLK1/SEG14	34	LED13
B	IOA9/EINT9/ADC_CH4/SEG49	IOA15/RX3/ISO7816_I01/EINT15/SEG15	33	LED14
17	IOA11/EINT11/ADC_CH6/SEG47	IOC0/SPICLK2/SEG16	32	LED15
18	IOB7/TX5/SEG46	IOC1/SPICLK2/SEG17	31	LED16
19	IOB1/RX5/PLLH_DIV/SEG45	IOC2/SPIMISO2/SEG18	30	LED17
20	IOB6/TX4/PWM1/RTCLK_out/SEG44	IOC3/SPIMOSI2/SEG19	29	LED18
21	IOB0/RX4/PWM0/SEG43	IOC4/I2CSCL2/SEG20	28	SCL
22	IOB2/SPIMISO/SEG39	IOC5/I2CSDA2/SEG21	27	SDA
23	IOB11/SPIMISO/SEG38	IOC6/SEG22	26	LED19
24	IOB10/SPICLK/SEG37	IOC7/SEG23	25	LED20

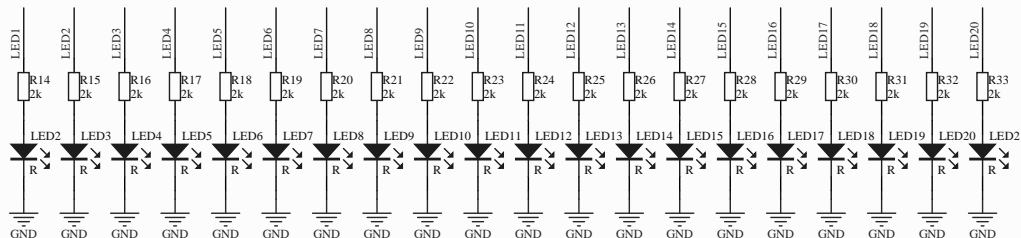

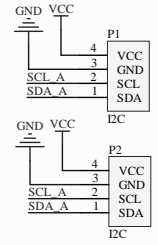

PCB Information	Name:[SEN0502](V1.0.0)	Thickness: 1.6mm
Engineer:Aaron	Top SolderMask: Black	Bottom SolderMask: Black
Date: 20220106	Top Silkscreen: White	Bottom Silkscreen: White

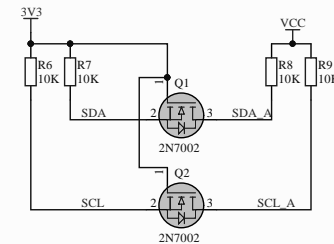
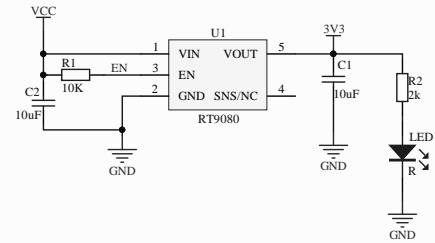
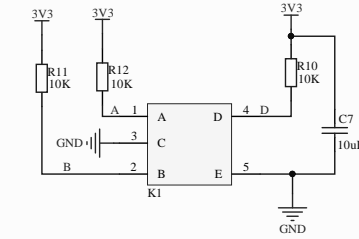
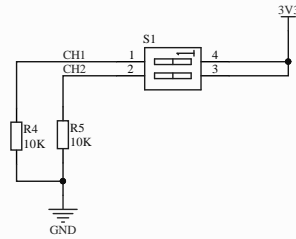
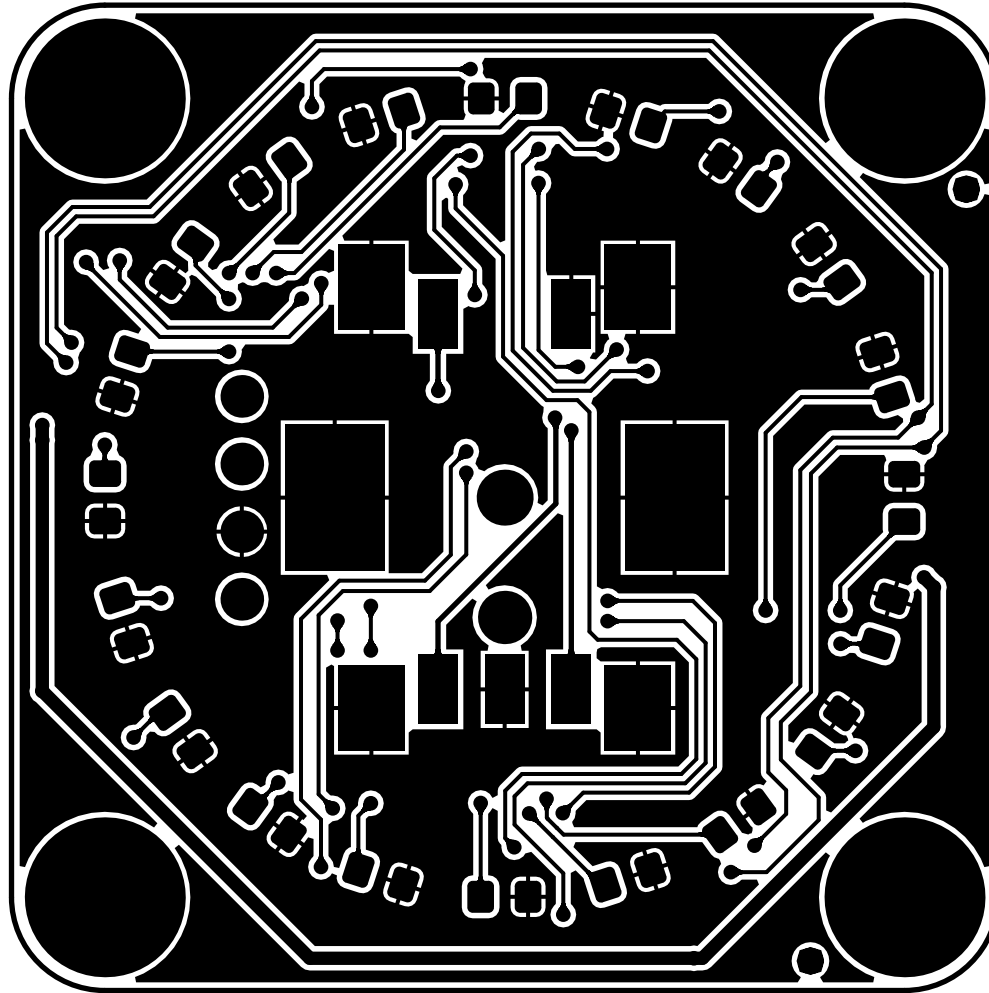
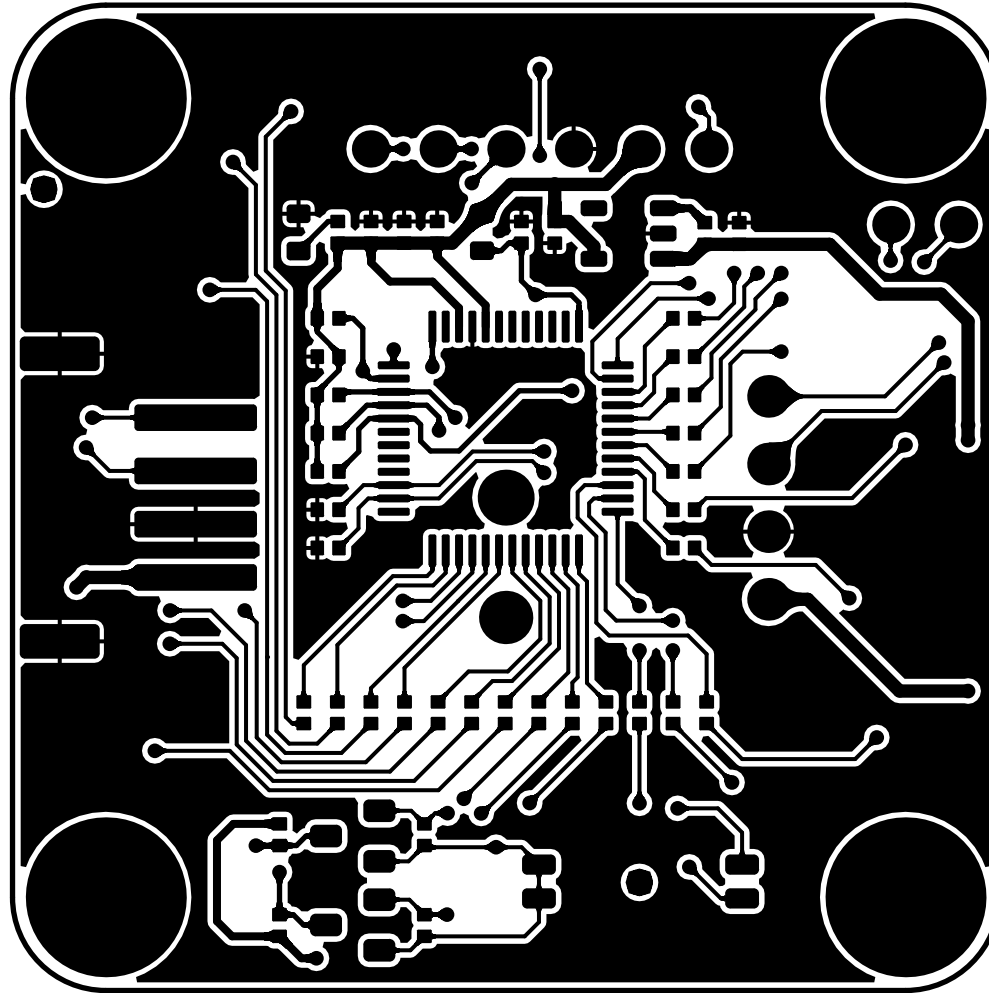

PCB Information	Name:[SEN0502](V1.0.0)	Thickness: 1.6mm
Engineer:Aaron	Top SolderMask: Black	Bottom SolderMask: Black
Date: 20220106	Top Silkscreen: White	Bottom Silkscreen: White

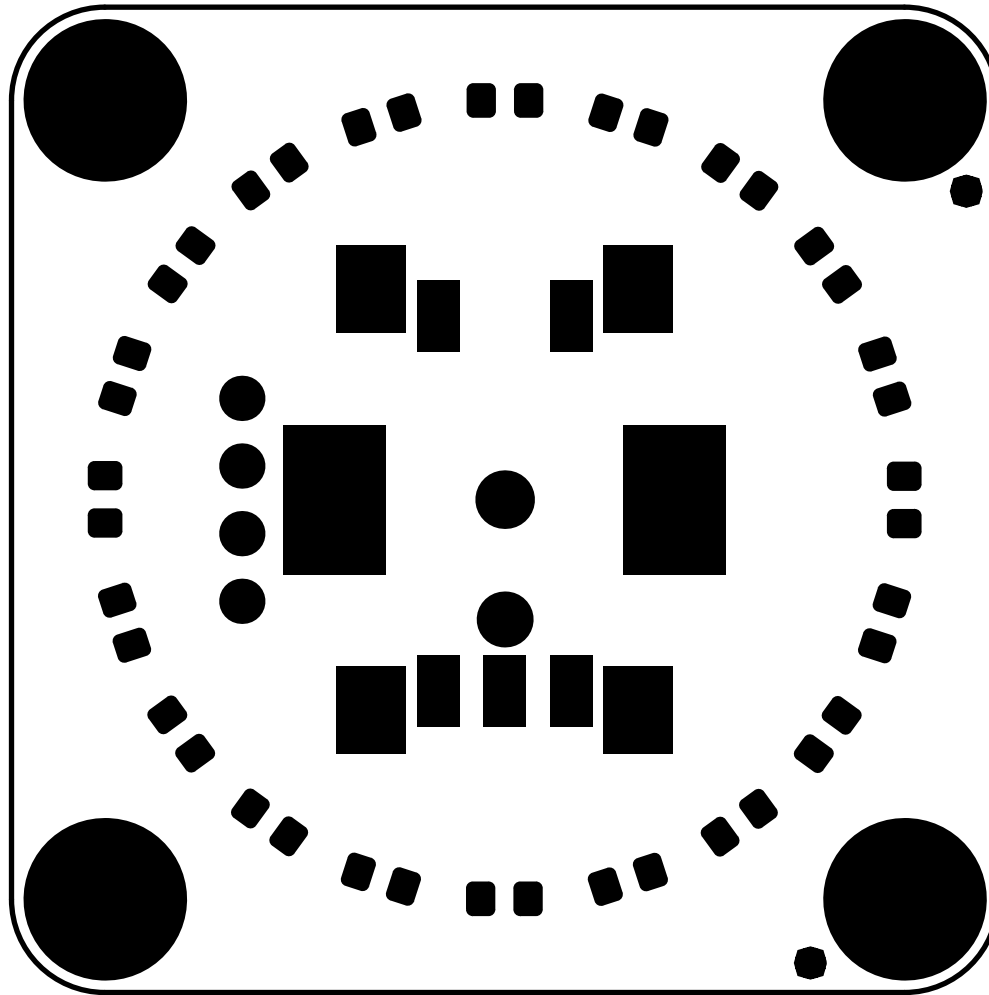

PCB Information	Name:[SEN0502](V1.0.0)	Thickness: 1.6mm
Engineer:Aaron	Top SolderMask: Black	Bottom SolderMask: Black
Date: 20220106	Top Silkscreen: White	Bottom Silkscreen: White

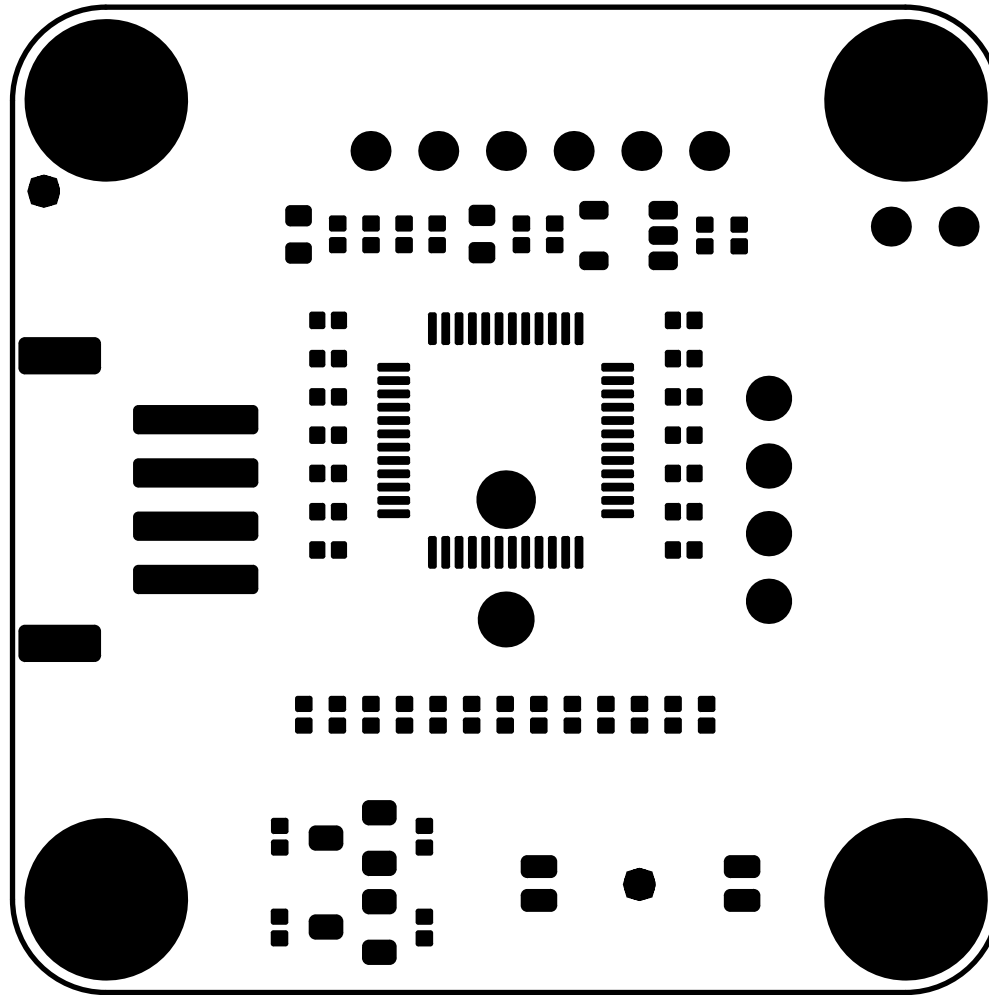

PCB Information	Name:[SEN0502](V1.0.0)	Thickness: 1.6mm
Engineer:Aaron	Top SolderMask: Black	Bottom SolderMask: Black
Date: 20220106	Top Silkscreen: White	Bottom Silkscreen: White

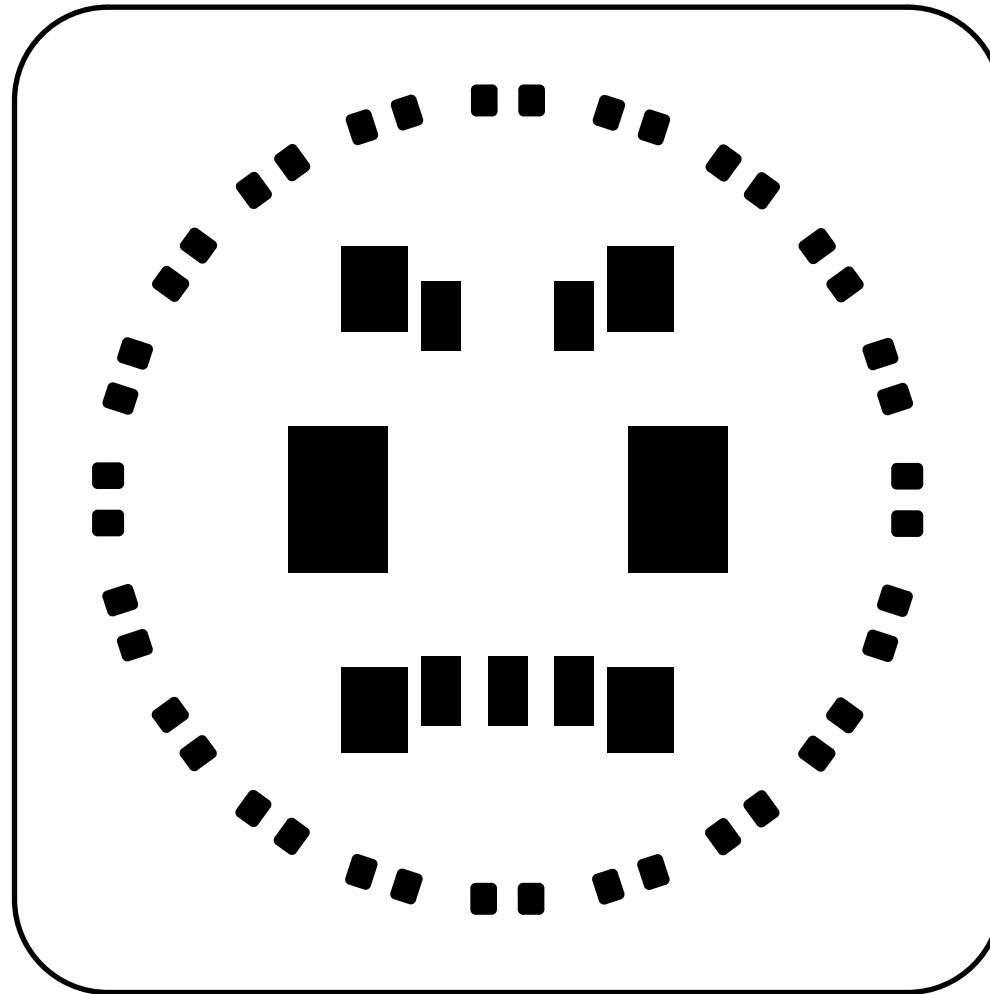

PCB Information	Name:[SEN0502](V1.0.0)	Thickness: 1.6mm
Engineer:Aaron	Top SolderMask: Black	Bottom SolderMask: Black
Date: 20220106	Top Silkscreen: White	Bottom Silkscreen: White

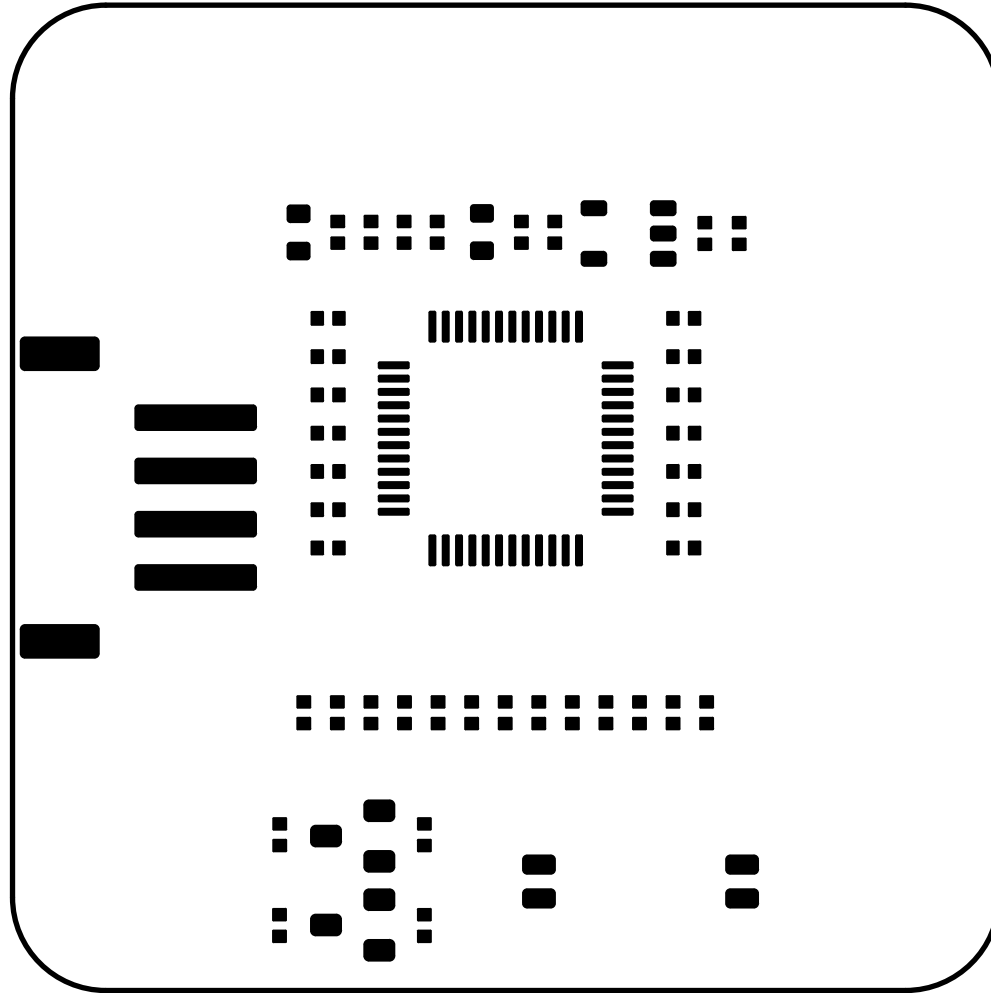

PCB Information	Name:[SEN0502](V1.0.0)	Thickness: 1.6mm
Engineer:Aaron	Top SolderMask: Black	Bottom SolderMask: Black
Date: 20220106	Top Silkscreen: White	Bottom Silkscreen: White

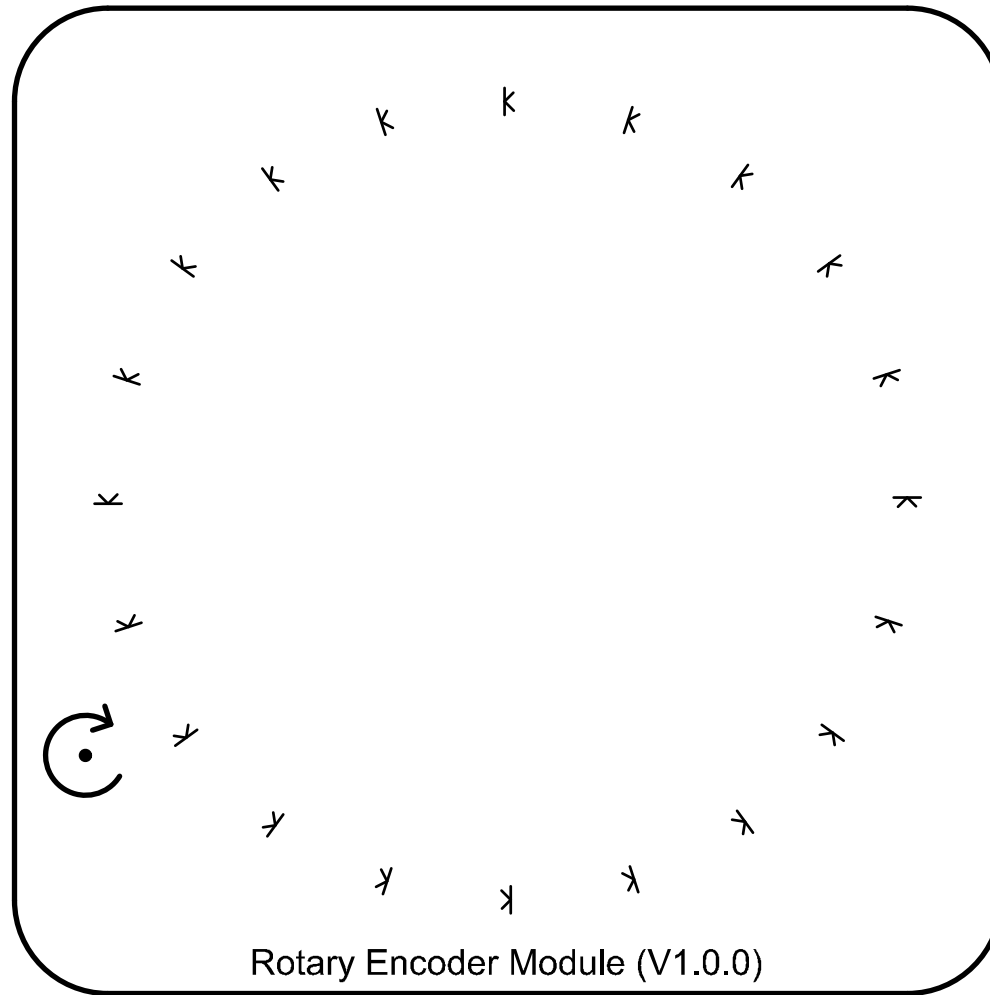

PCB Information	Name:[SEN0502](V1.0.0)	Thickness: 1.6mm
Engineer:Aaron	Top SolderMask: Black	Bottom SolderMask: Black
Date: 20220106	Top Silkscreen: White	Bottom Silkscreen: White

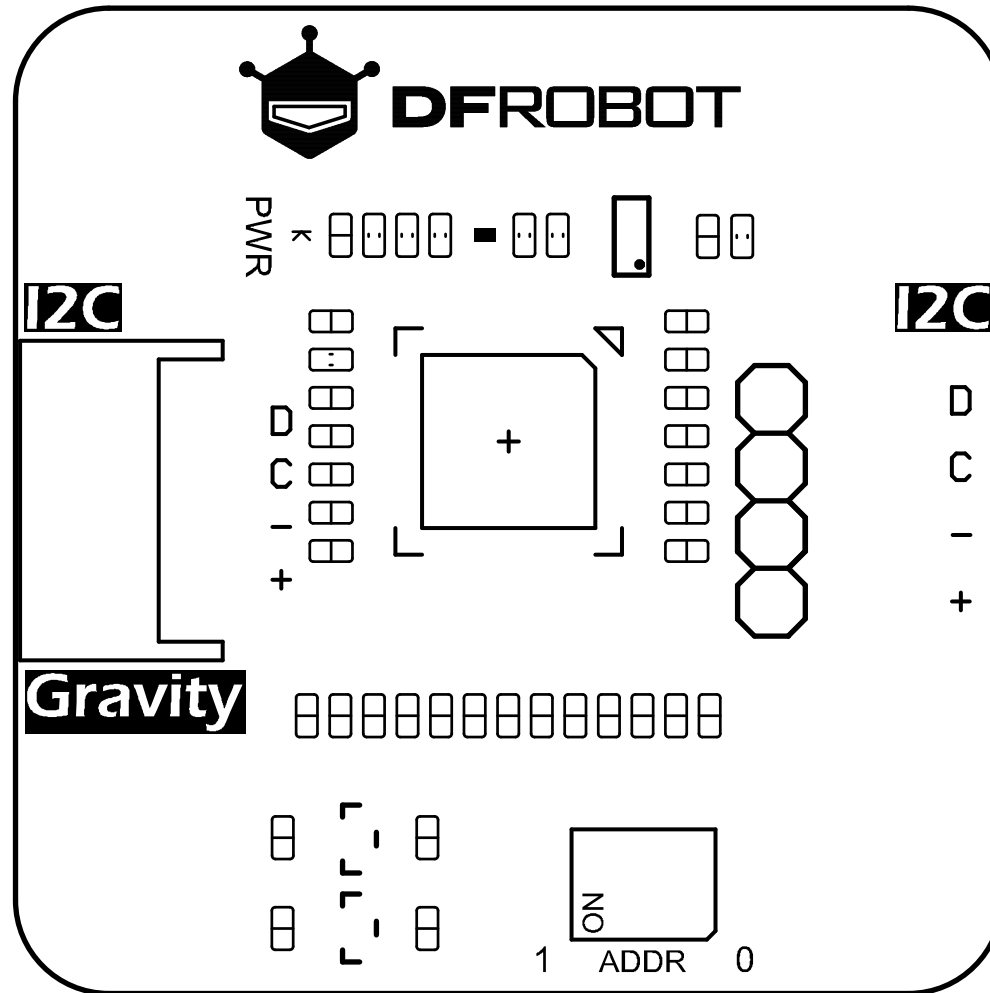

PCB Information	Name:[SEN0502](V1.0.0)	Thickness: 1.6mm
Engineer:Aaron	Top SolderMask: Black	Bottom SolderMask: Black
Date: 20220106	Top Silkscreen: White	Bottom Silkscreen: White

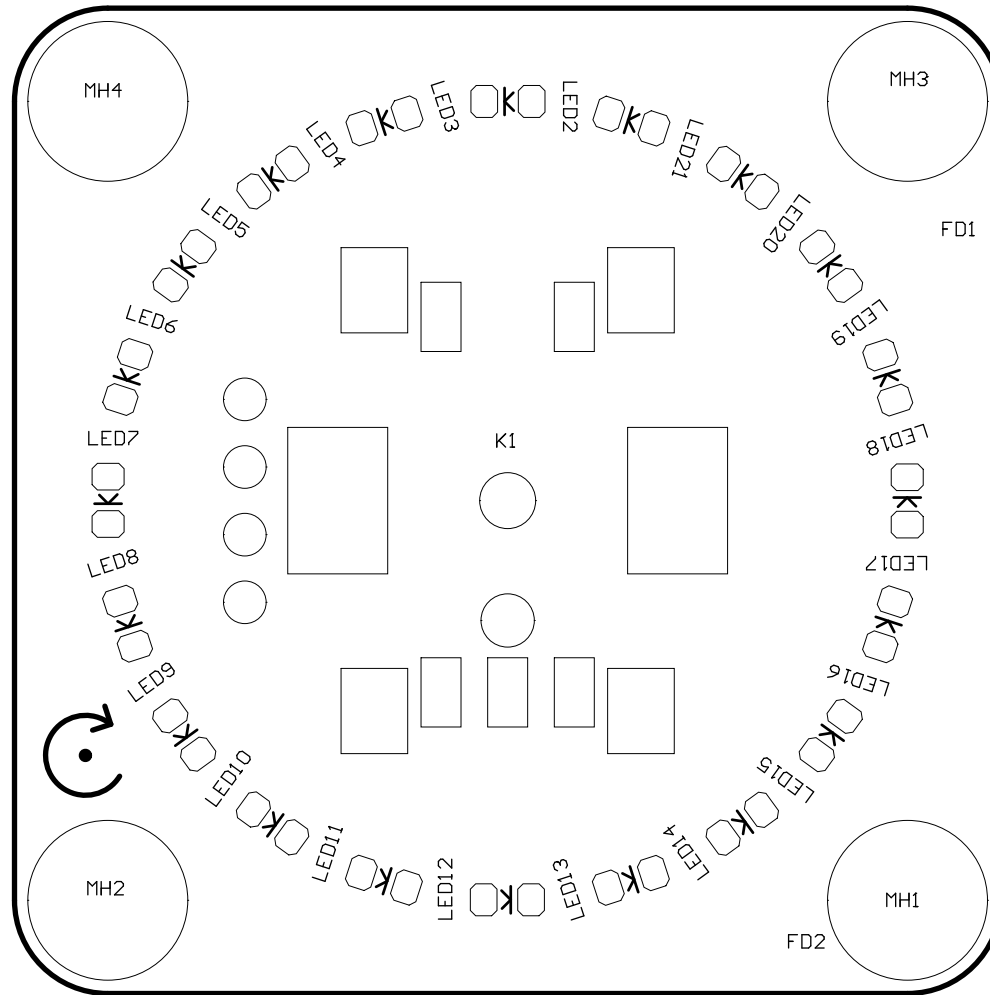

PCB Information	Name:[SEN0502](V1.0.0)	Thickness: 1.6mm
Engineer:Aaron	Top SolderMask: Black	Bottom SolderMask: Black
Date: 20220106	Top Silkscreen: White	Bottom Silkscreen: White

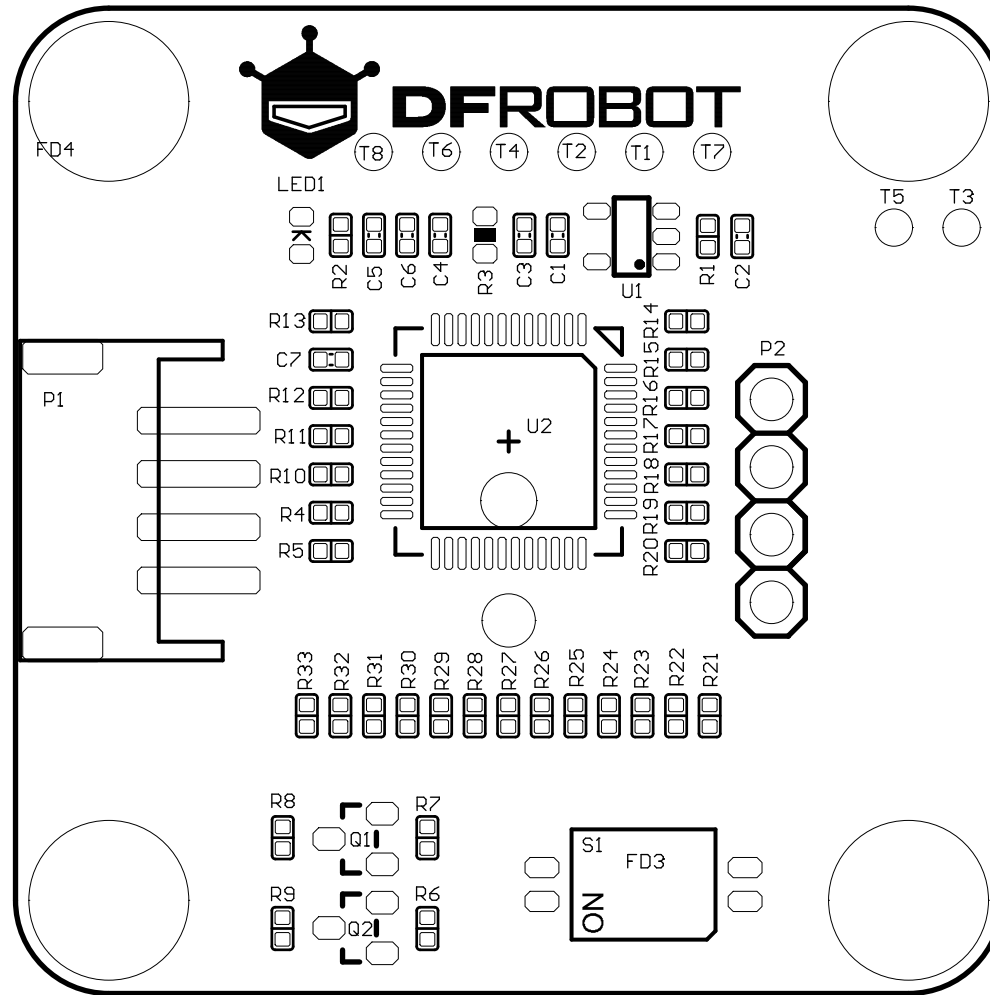

PCB Information	Name:[SEN0502](V1.0.0)	Thickness: 1.6mm
Engineer:Aaron	Top SolderMask: Black	Bottom SolderMask: Black
Date: 20220106	Top Silkscreen: White	Bottom Silkscreen: White

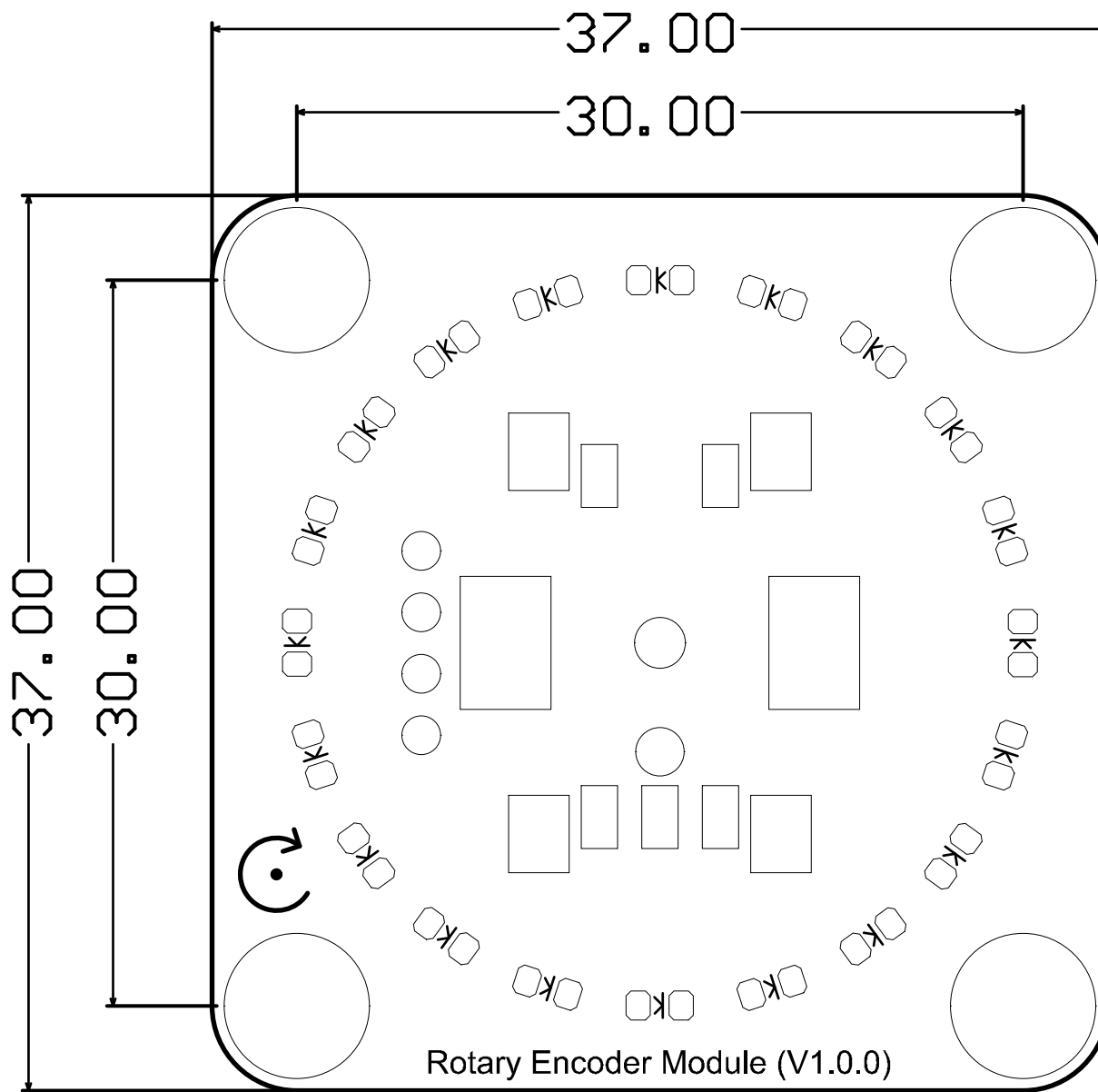

PCB Information	Name:[SEN0502](V1.0.0)	Thickness: 1.6mm
Engineer:Aaron	Top SolderMask: Black	Bottom SolderMask: Black
Date: 20220106	Top Silkscreen: White	Bottom Silkscreen: White

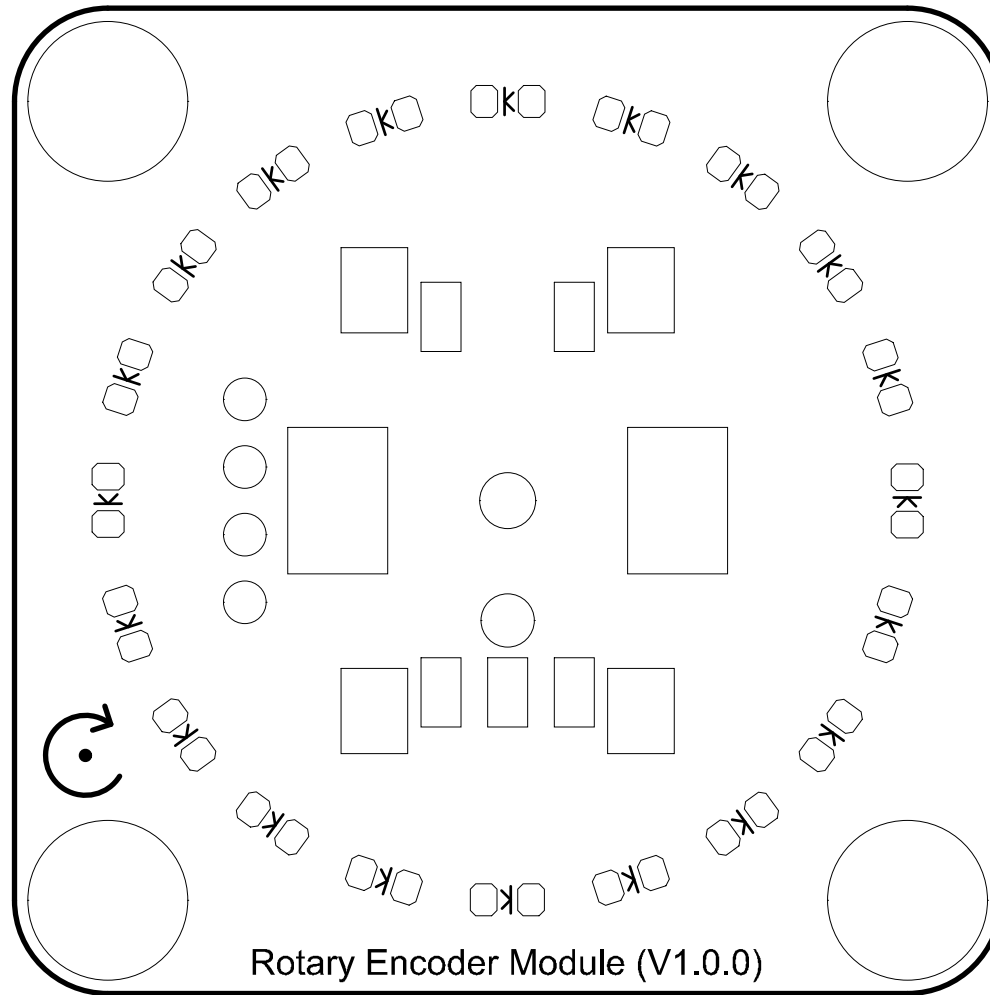

PCB Information	Name:[SEN0502](V1.0.0)	Thickness: 1.6mm
Engineer:Aaron	Top SolderMask: Black	Bottom SolderMask: Black
Date: 20220106	Top Silkscreen: White	Bottom Silkscreen: White

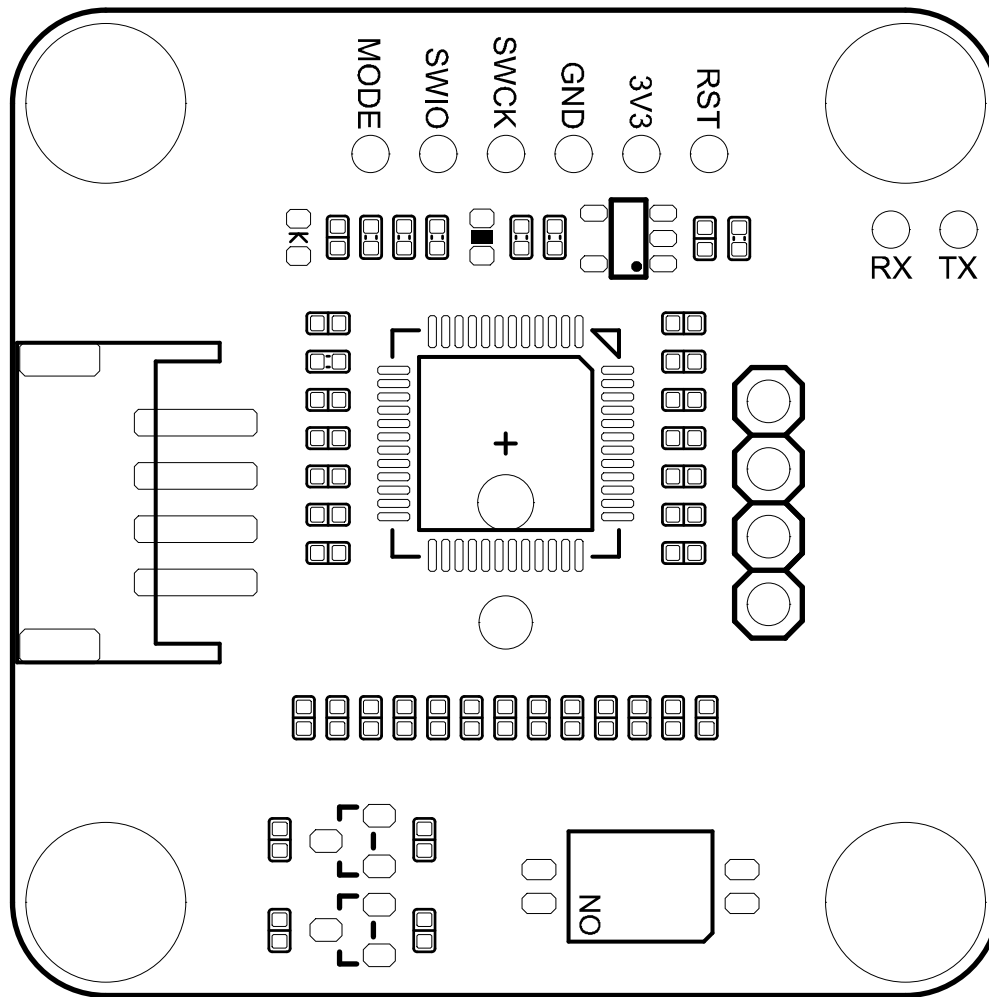

PCB Information	Name:[SEN0502](V1.0.0)	Thickness: 1.6mm
Engineer:Aaron	Top SolderMask: Black	Bottom SolderMask: Black
Date: 20220106	Top Silkscreen: White	Bottom Silkscreen: White