

PCB Information	Name:[DFR0971](V1.0.0)	Thickness: 1.0mm
Engineer:Aaron	Top SolderMask: Black	Bottom SolderMask: Black
Date: 20220727	Top Silkscreen: White	Bottom Silkscreen: White

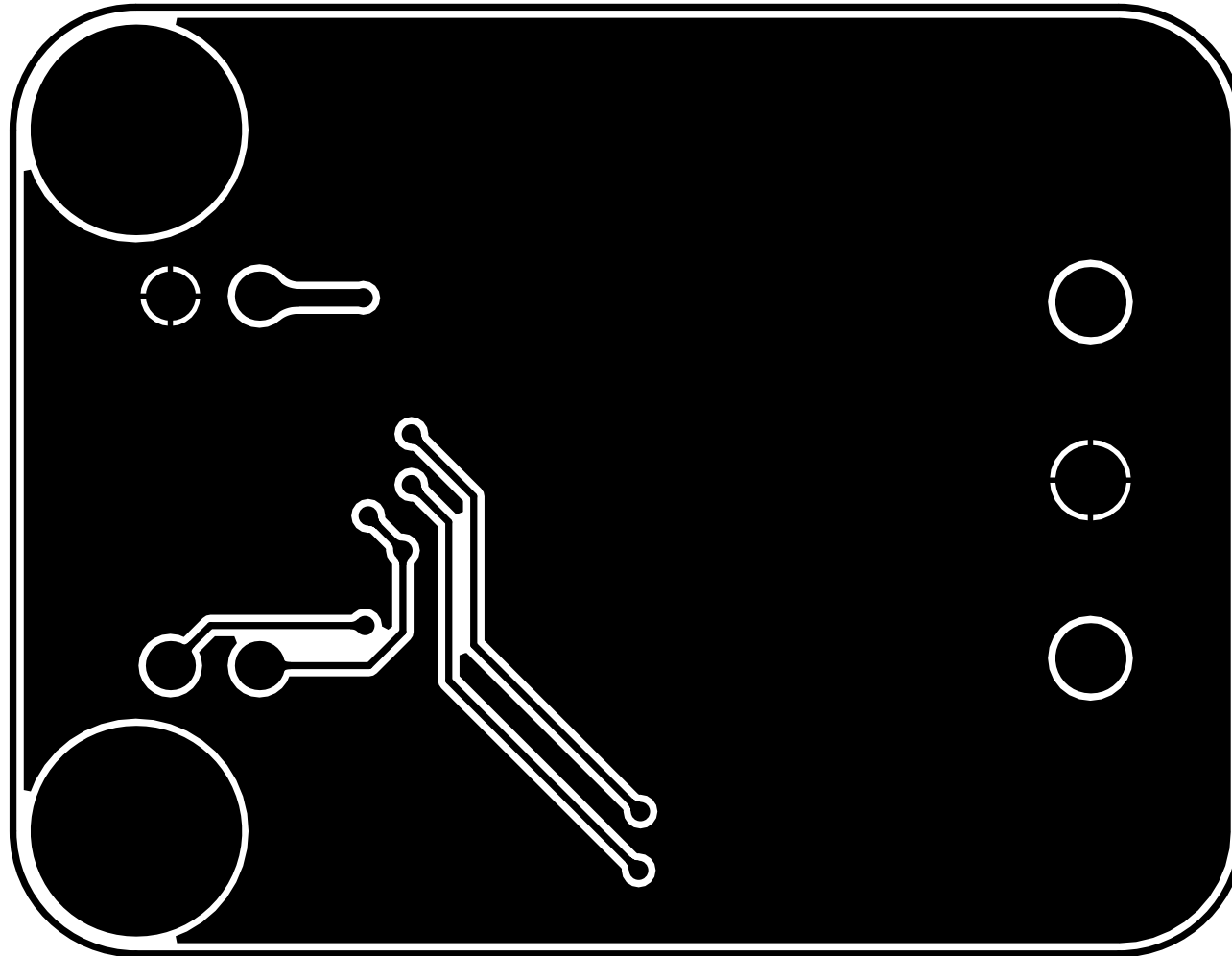

PCB Information	Name:[DFR0971](V1.0.0)	Thickness: 1.0mm
Engineer:Aaron	Top SolderMask: Black	Bottom SolderMask: Black
Date: 20220727	Top Silkscreen: White	Bottom Silkscreen: White

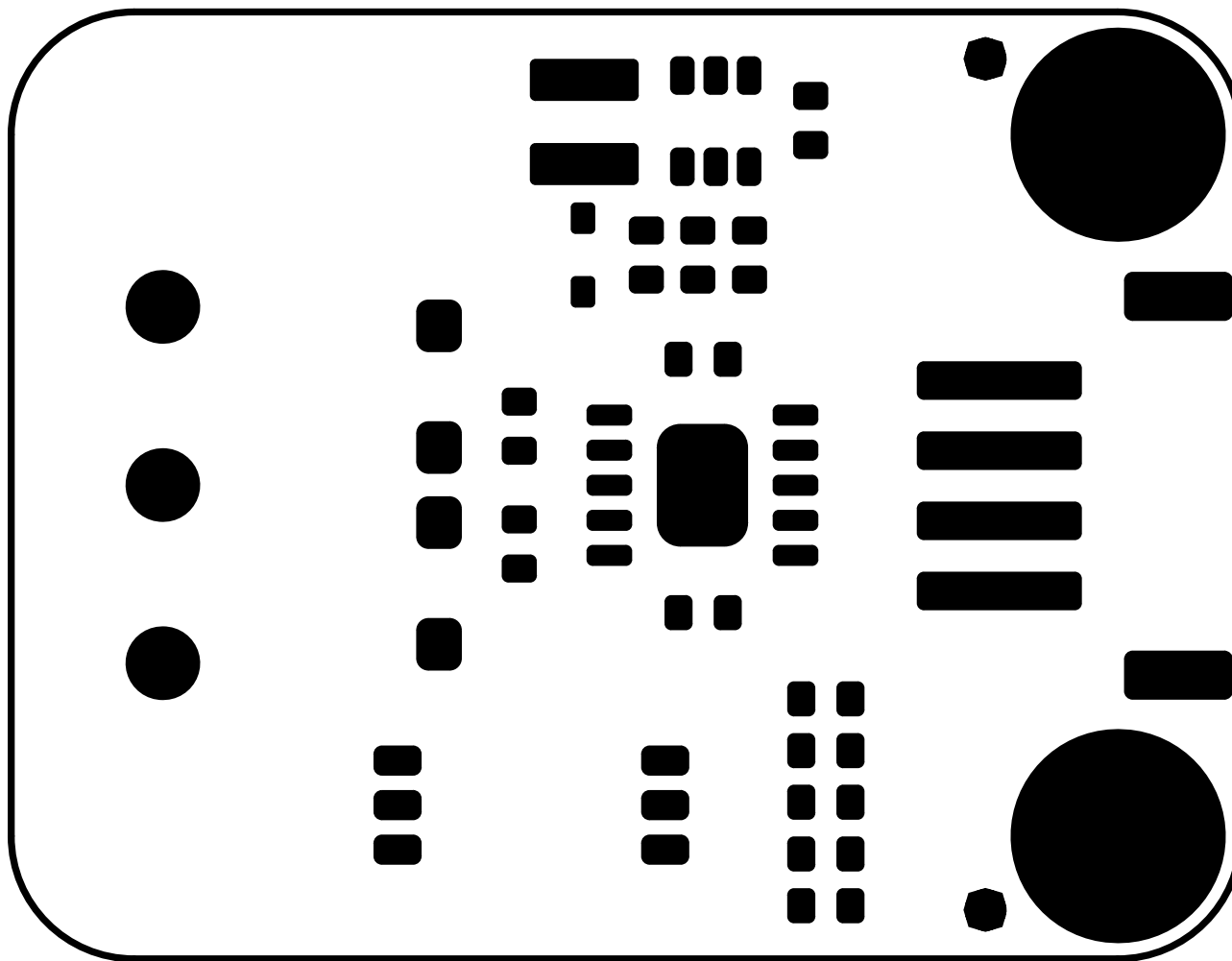

PCB Information	Name:[DFR0971](V1.0.0)	Thickness: 1.0mm
Engineer:Aaron	Top SolderMask: Black	Bottom SolderMask: Black
Date: 20220727	Top Silkscreen: White	Bottom Silkscreen: White

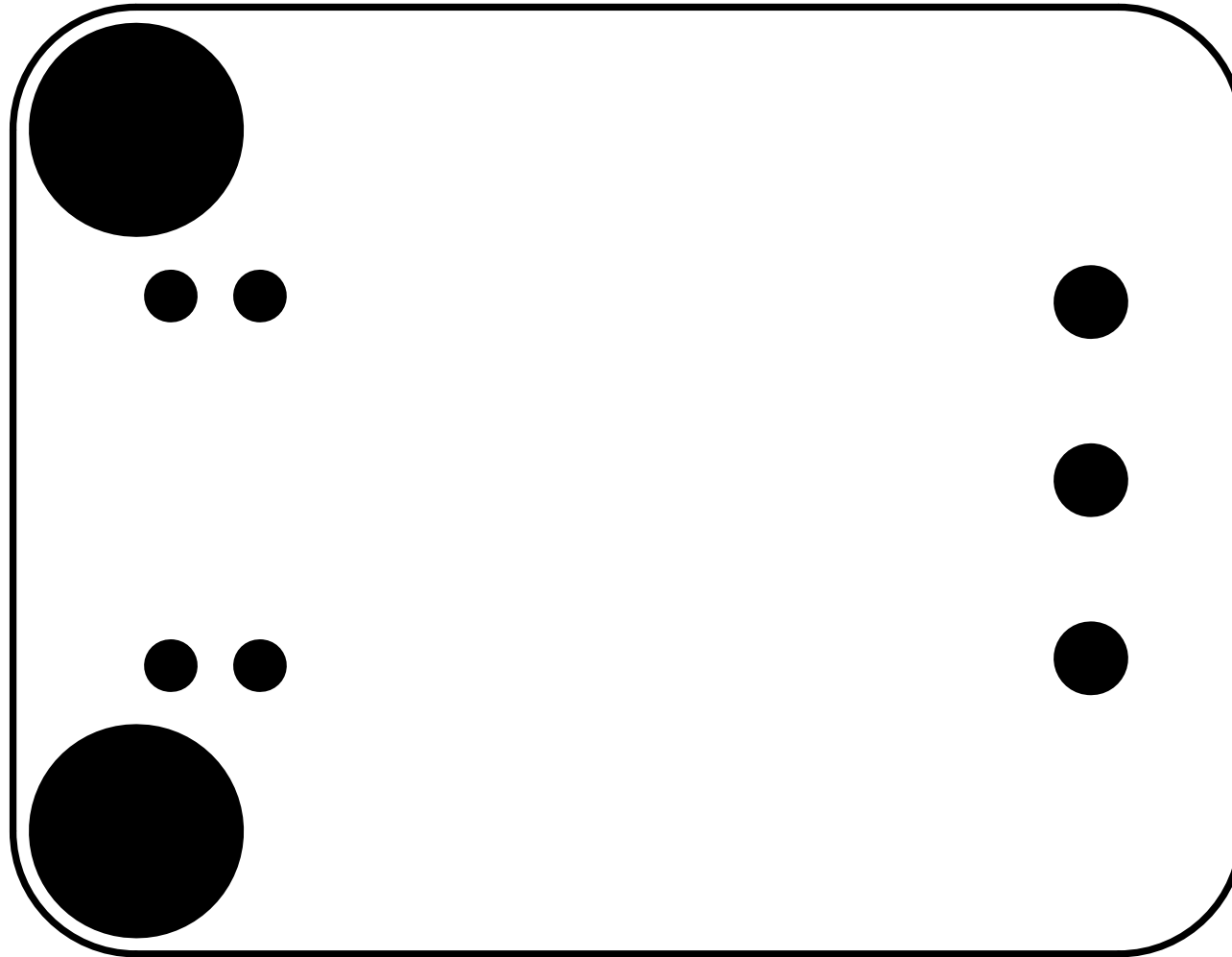

PCB Information	Name:[DFR0971](V1.0.0)	Thickness: 1.0mm
Engineer:Aaron	Top SolderMask: Black	Bottom SolderMask: Black
Date: 20220727	Top Silkscreen: White	Bottom Silkscreen: White

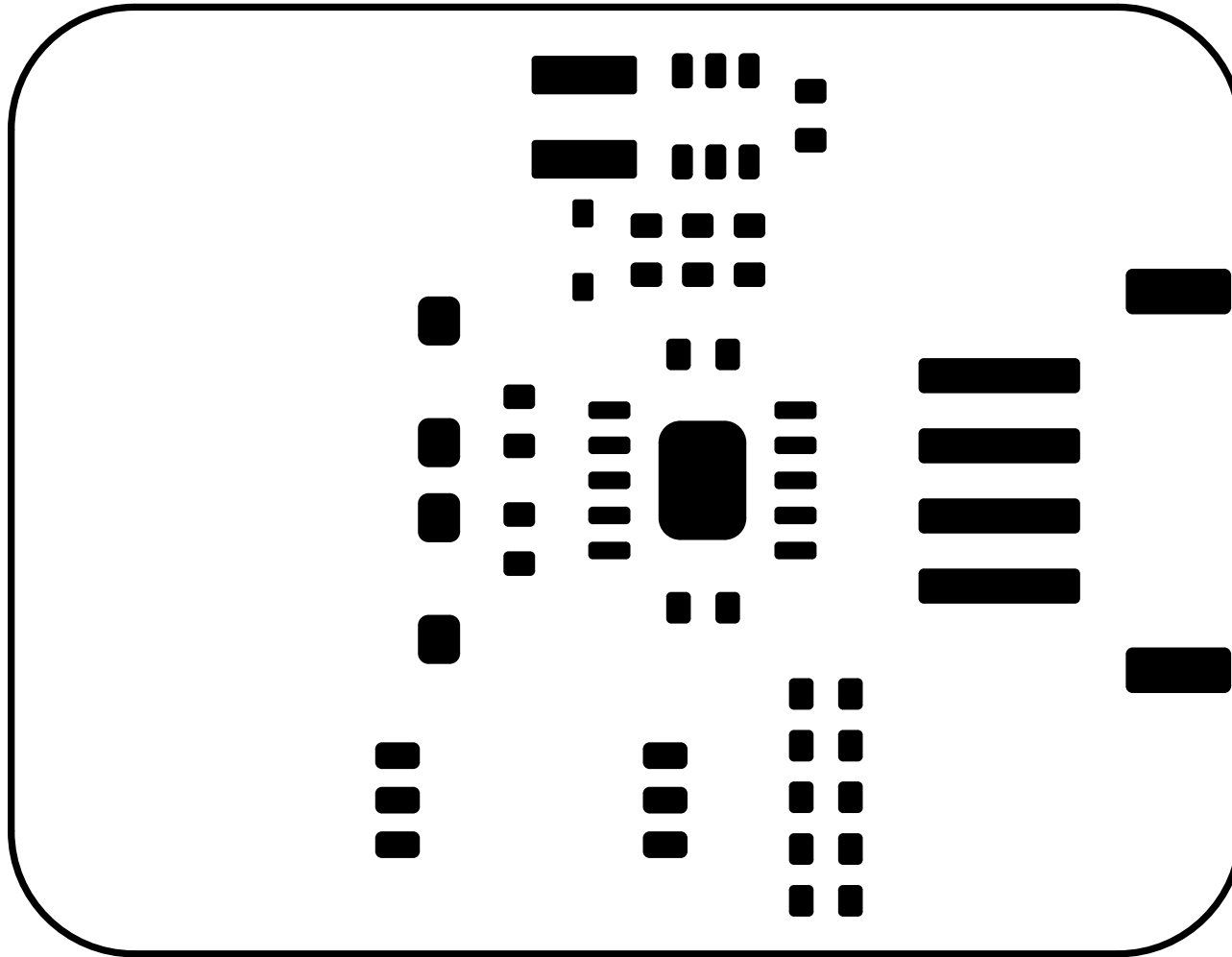

PCB Information	Name:[DFR0971](V1.0.0)	Thickness: 1.0mm
Engineer:Aaron	Top SolderMask: Black	Bottom SolderMask: Black
Date: 20220727	Top Silkscreen: White	Bottom Silkscreen: White

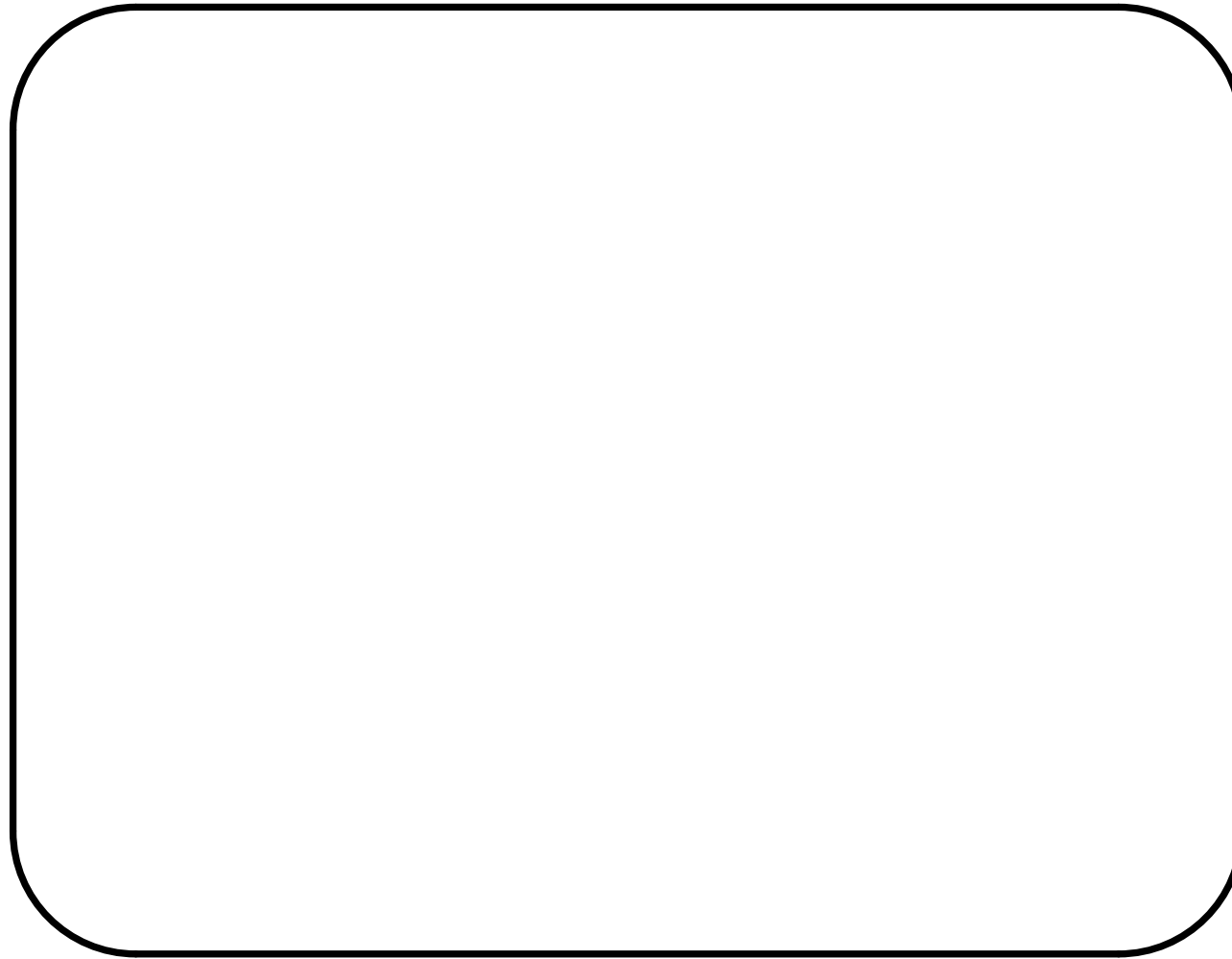

PCB Information	Name:[DFR0971](V1.0.0)	Thickness: 1.0mm
Engineer:Aaron	Top SolderMask: Black	Bottom SolderMask: Black
Date: 20220727	Top Silkscreen: White	Bottom Silkscreen: White

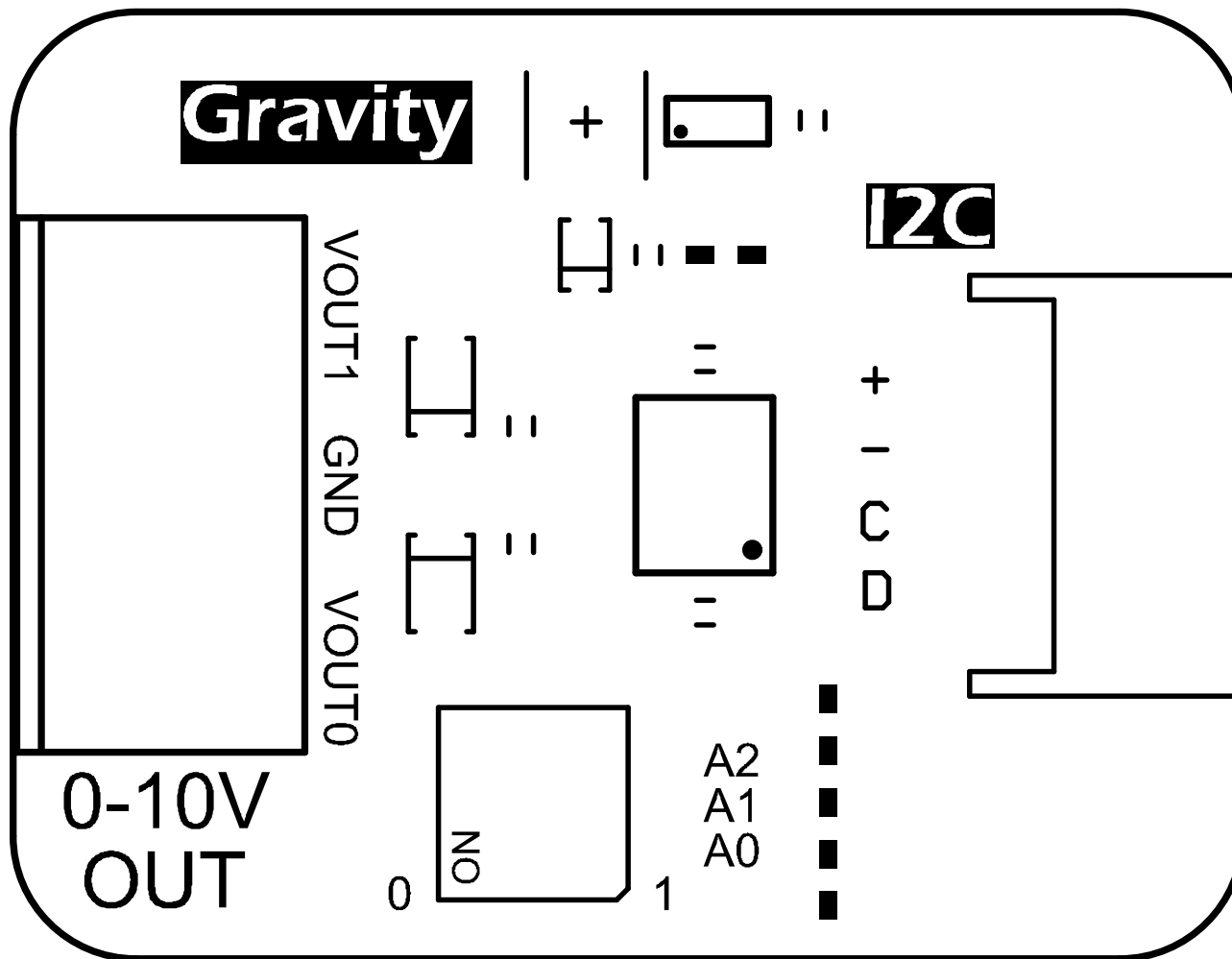

PCB Information	Name:[DFR0971](V1.0.0)	Thickness: 1.0mm
Engineer:Aaron	Top SolderMask: Black	Bottom SolderMask: Black
Date: 20220727	Top Silkscreen: White	Bottom Silkscreen: White

100

DFROBOT

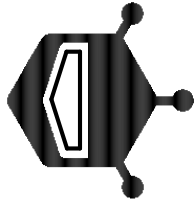

A2	A1	A0	ADDR
0	0	0	0X58
0	0	1	0X59
0	1	0	0X5A
0	1	1	0X5B
1	0	0	0X5C
1	0	1	0X5D
1	1	0	0X5E
1	1	1	0X5F

I2C to 2 channels to 0~10V analog
voltage module V1.0

PCB Information

Name:[DFR0971](V1.0.0)

Thickness: 1.0mm

Engineer:Aaron

Top SolderMask: Black

Bottom SolderMask: Black

Date: 20220727

Top Silkscreen: White

Bottom Silkscreen: White

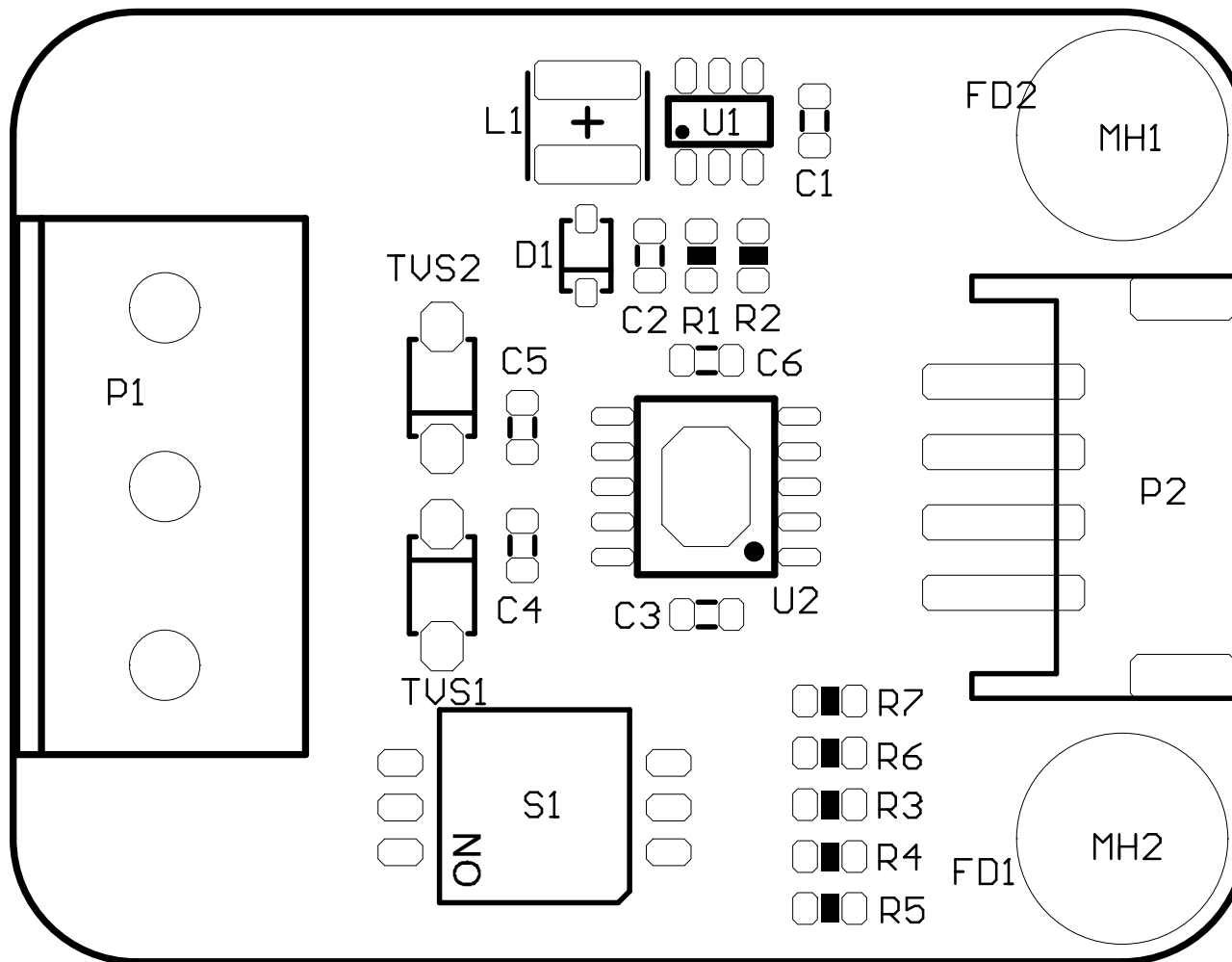

PCB Information	Name:[DFR0971](V1.0.0)	Thickness: 1.0mm
Engineer:Aaron	Top SolderMask: Black	Bottom SolderMask: Black
Date: 20220727	Top Silkscreen: White	Bottom Silkscreen: White

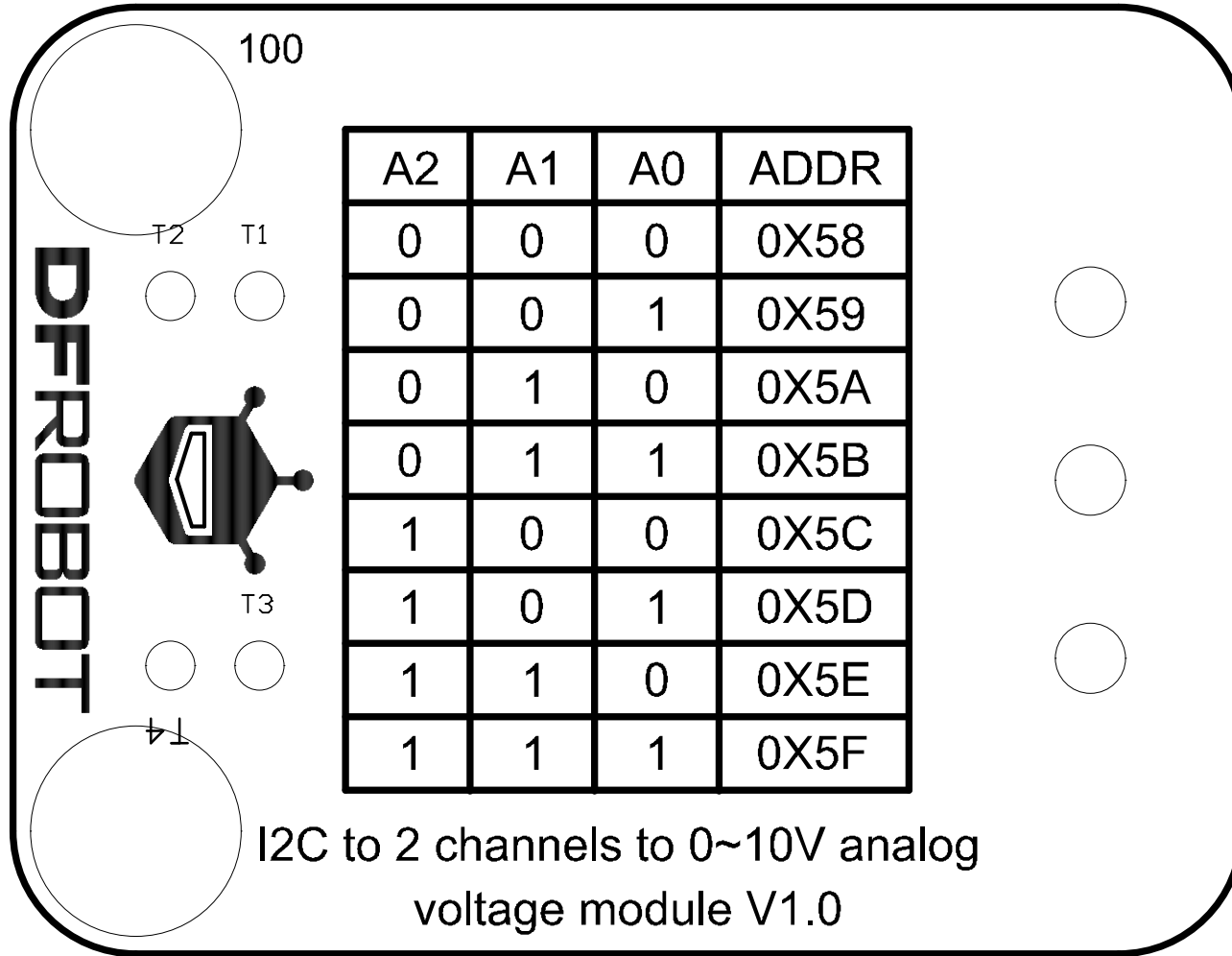

PCB Information	Name:[DFR0971](V1.0.0)	Thickness: 1.0mm
Engineer:Aaron	Top SolderMask: Black	Bottom SolderMask: Black
Date: 20220727	Top Silkscreen: White	Bottom Silkscreen: White

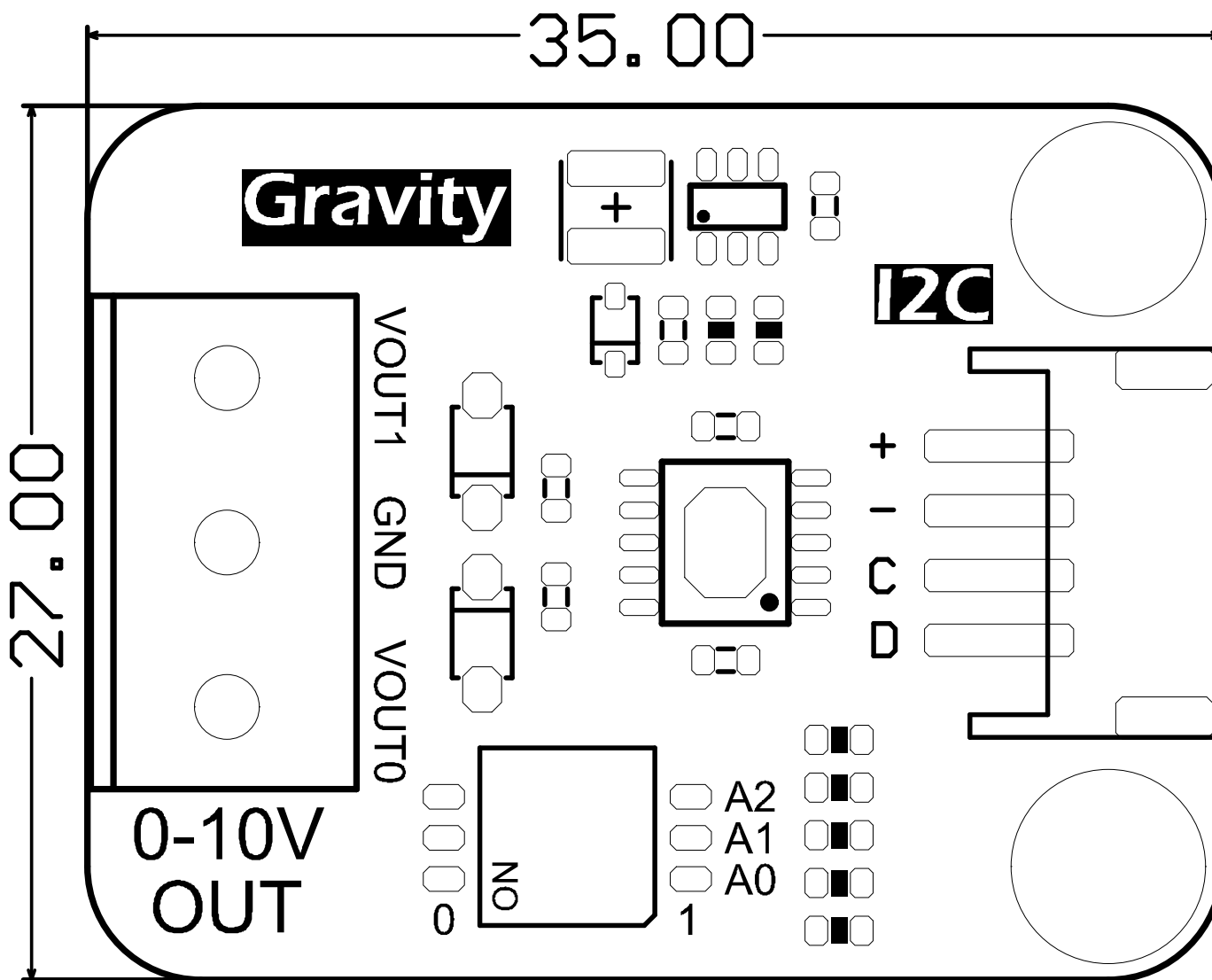

PCB Information	Name:[DFR0971](V1.0.0)	Thickness: 1.0mm
Engineer:Aaron	Top SolderMask: Black	Bottom SolderMask: Black
Date: 20220727	Top Silkscreen: White	Bottom Silkscreen: White

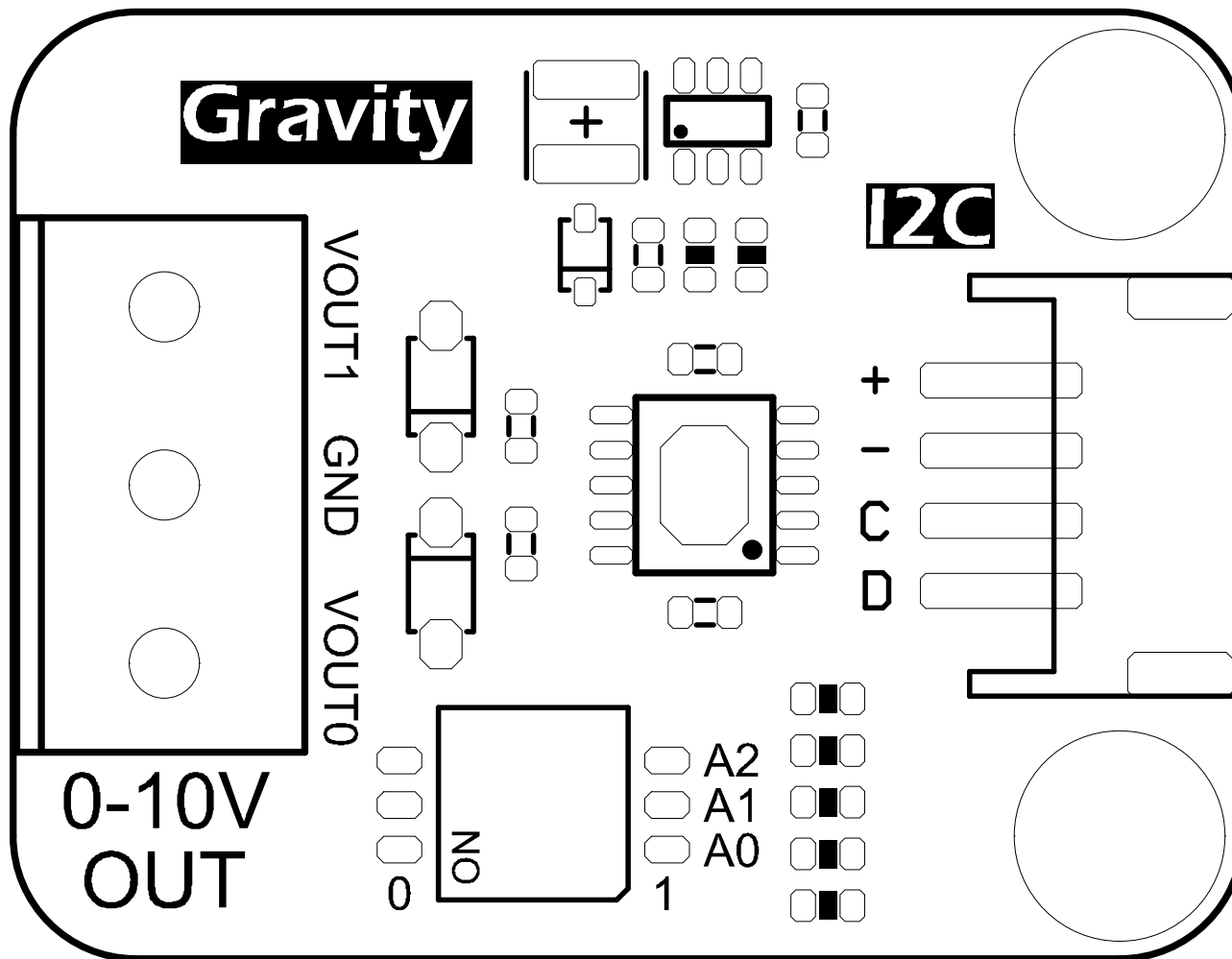

PCB Information	Name:[DFR0971](V1.0.0)	Thickness: 1.0mm
Engineer:Aaron	Top SolderMask: Black	Bottom SolderMask: Black
Date: 20220727	Top Silkscreen: White	Bottom Silkscreen: White

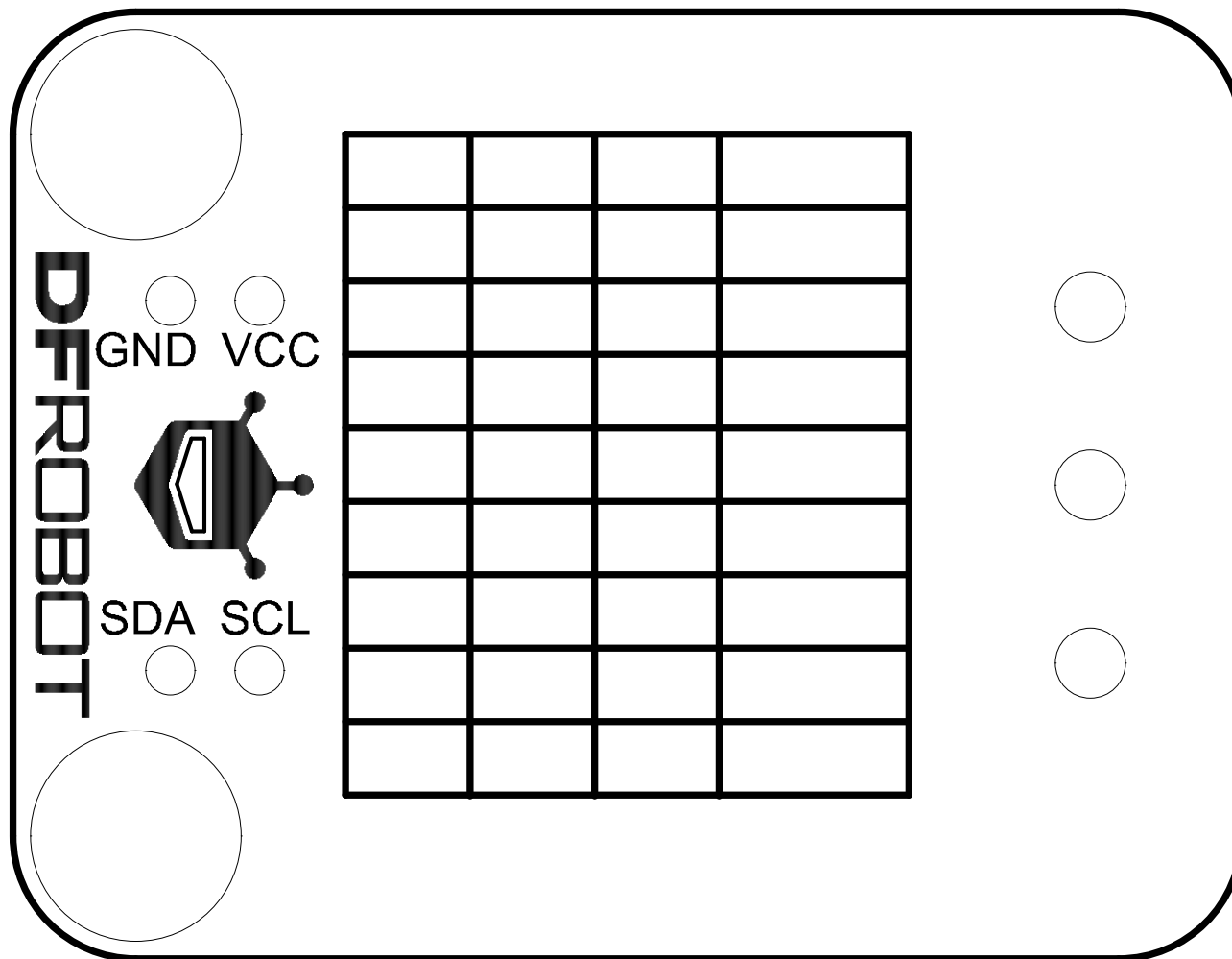

PCB Information	Name:[DFR0971](V1.0.0)	Thickness: 1.0mm
Engineer:Aaron	Top SolderMask: Black	Bottom SolderMask: Black
Date: 20220727	Top Silkscreen: White	Bottom Silkscreen: White