

PCB Information	Name:[TEL0162 CAT4][V1.0.0]	Thickness: 1.6mm
Engineer: YXD	Top SolderMask: Black	Bottom SolderMask: Black
Date: 20231031	Top Silkscreen: White	Bottom Silkscreen: White

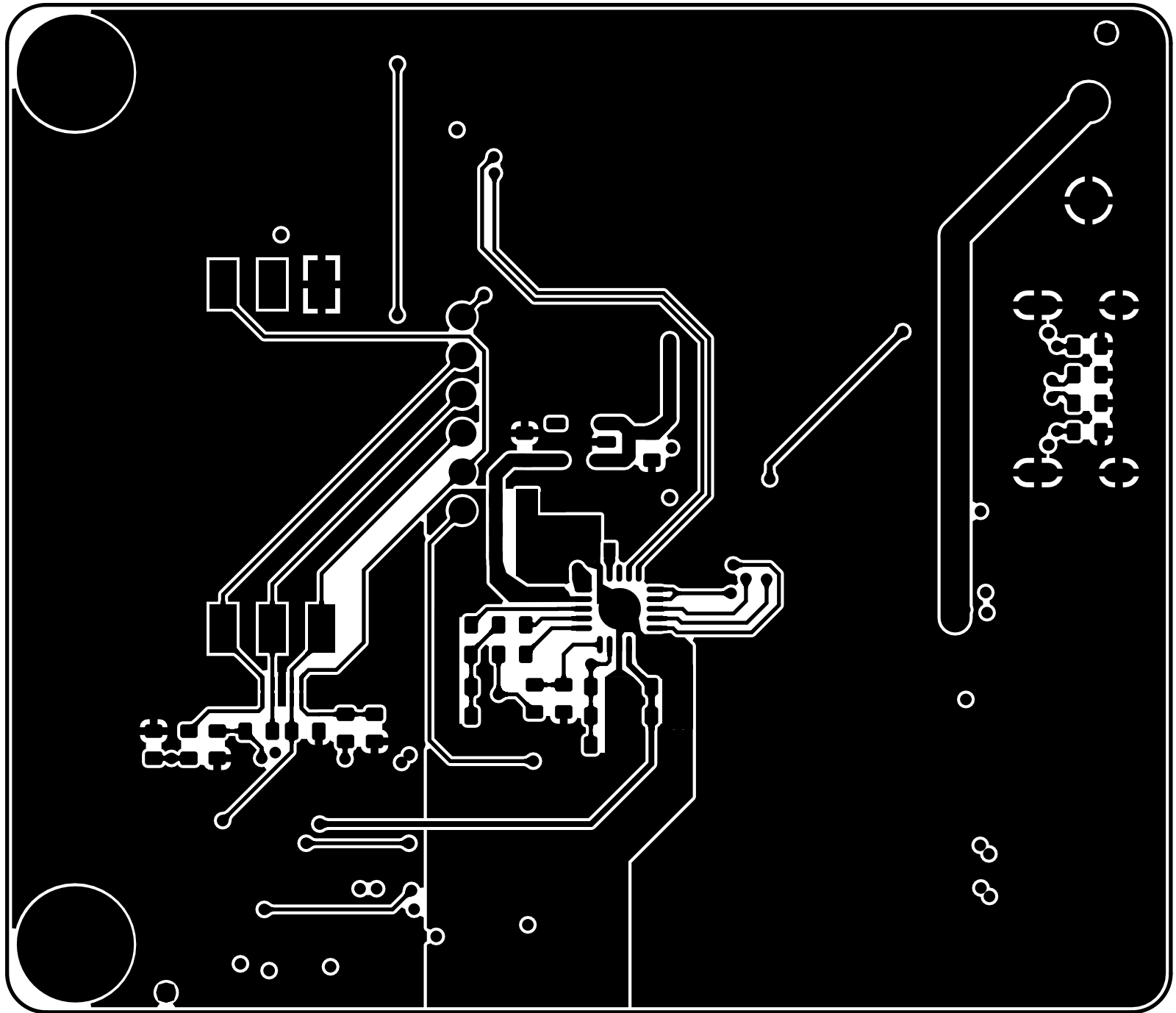

PCB Information	Name:[TEL0162 CAT4][V1.0.0]	Thickness: 1.6mm
Engineer: YXD	Top SolderMask: Black	Bottom SolderMask: Black
Date: 20231031	Top Silkscreen: White	Bottom Silkscreen: White

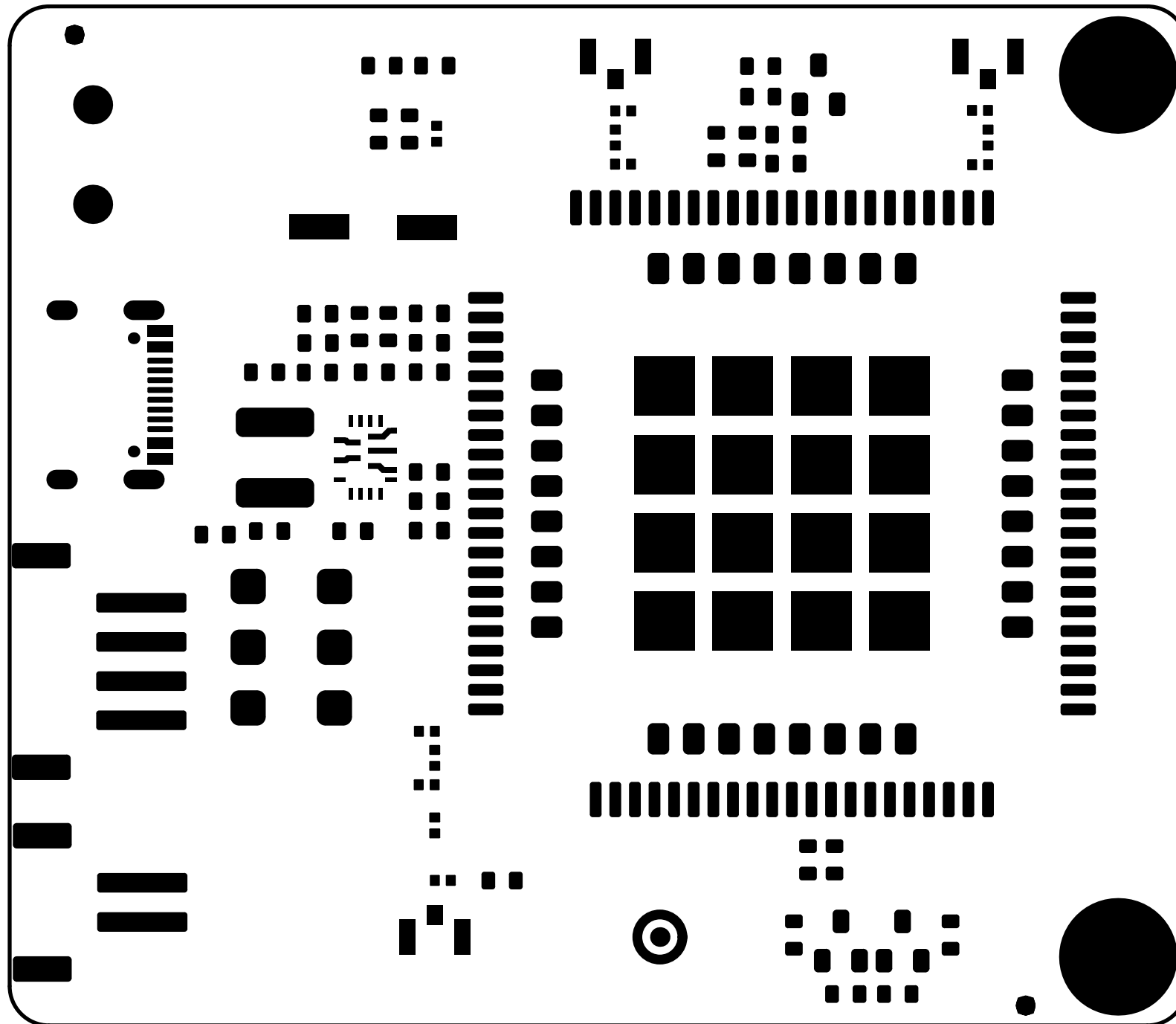

PCB Information	Name:[TEL0162 CAT4][V1.0.0]	Thickness: 1.6mm
Engineer: YXD	Top SolderMask: Black	Bottom SolderMask: Black
Date: 20231031	Top Silkscreen: White	Bottom Silkscreen: White

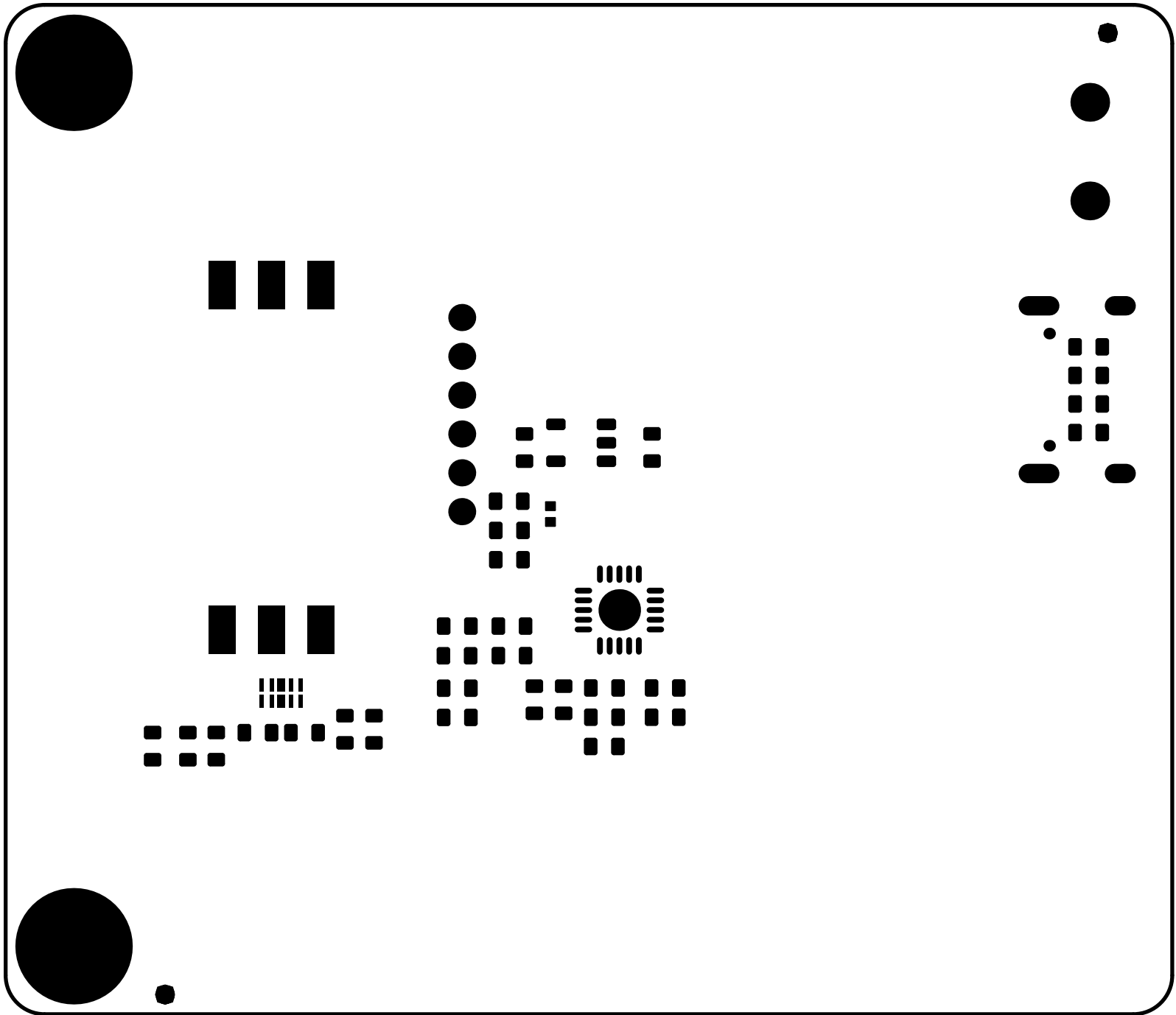

PCB Information	Name:[TEL0162 CAT4][V1.0.0]	Thickness: 1.6mm
Engineer: YXD	Top SolderMask: Black	Bottom SolderMask: Black
Date: 20231031	Top Silkscreen: White	Bottom Silkscreen: White

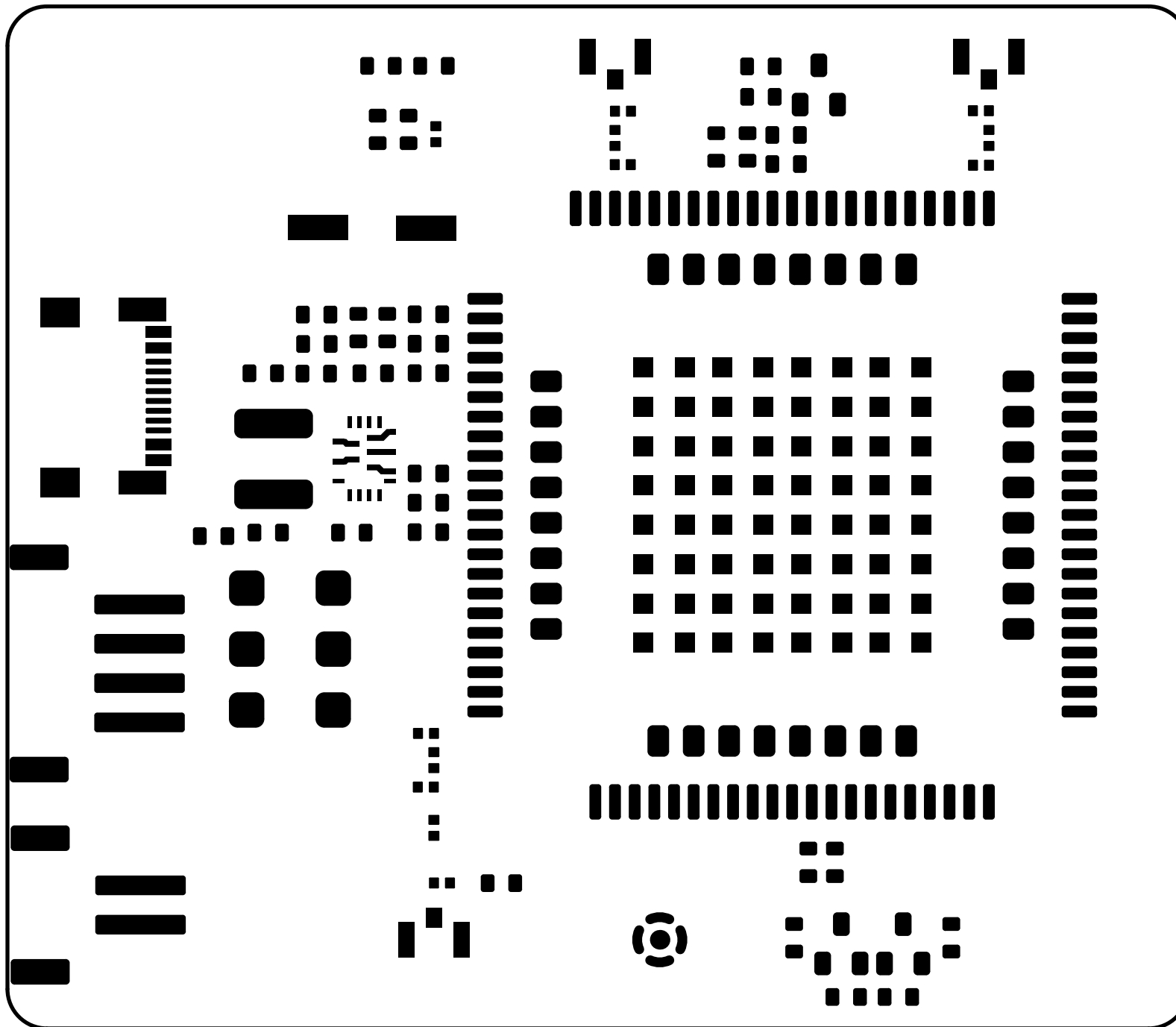

PCB Information	Name:[TEL0162 CAT4][V1.0.0]	Thickness: 1.6mm
Engineer: YXD	Top SolderMask: Black	Bottom SolderMask: Black
Date: 20231031	Top Silkscreen: White	Bottom Silkscreen: White

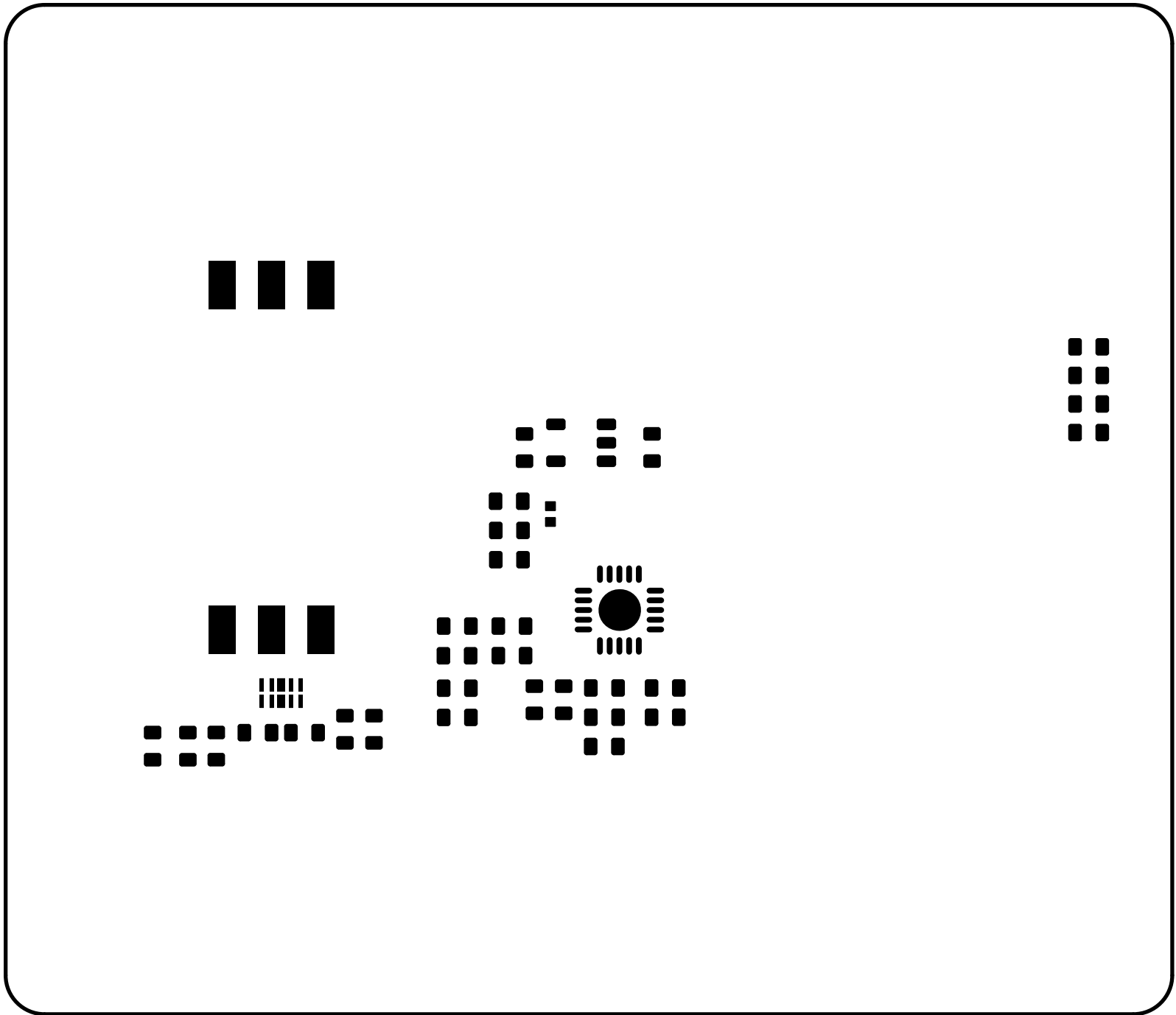

PCB Information	Name:[TEL0162 CAT4][V1.0.0]	Thickness: 1.6mm
Engineer: YXD	Top SolderMask: Black	Bottom SolderMask: Black
Date: 20231031	Top Silkscreen: White	Bottom Silkscreen: White

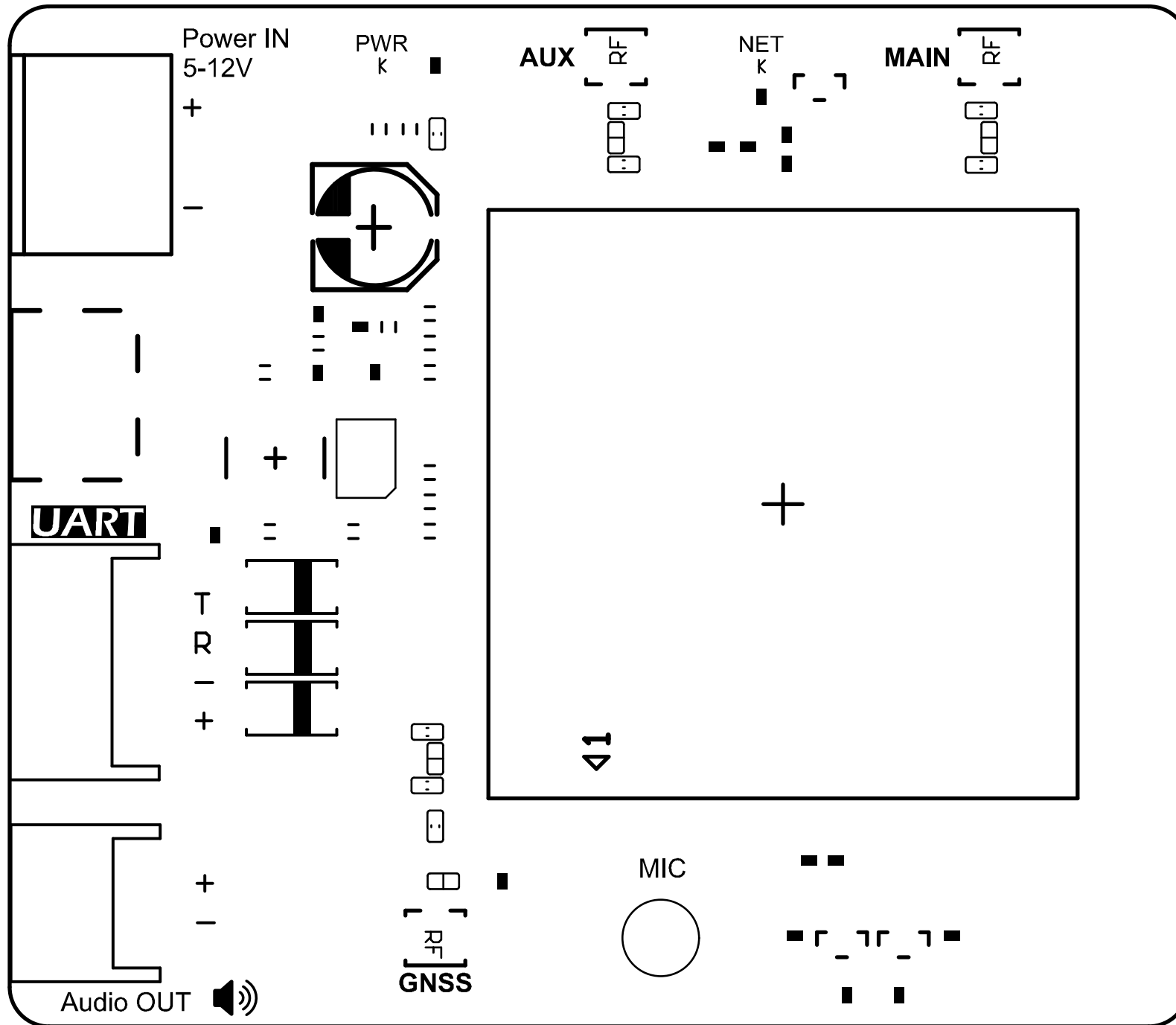

PCB Information		Name:[TEL0162 CAT4][V1.0.0]	Thickness: 1.6mm
Engineer: YXD	Top SolderMask: Black	Bottom SolderMask: Black	
Date: 20231031	Top Silkscreen: White	Bottom Silkscreen: White	

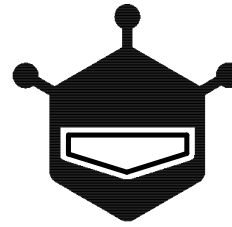
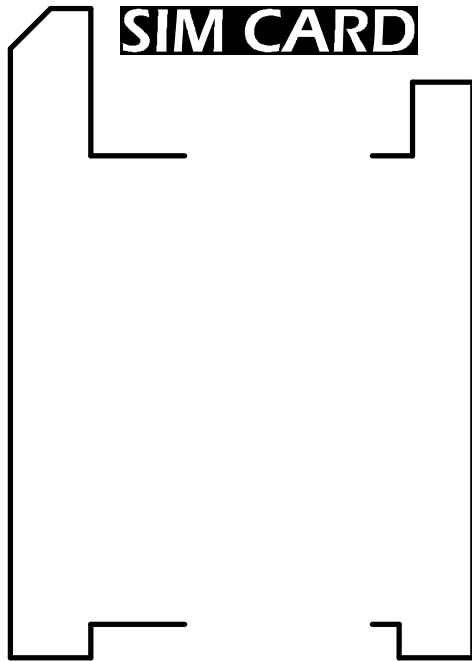

DFROBOT



SIM7600G-H CAT4 4G Communication Module V1.0

PCB Information	Name:[TEL0162 CAT4][V1.0.0]	Thickness: 1.6mm
Engineer: YXD	Top SolderMask: Black	Bottom SolderMask: Black
Date: 20231031	Top Silkscreen: White	Bottom Silkscreen: White

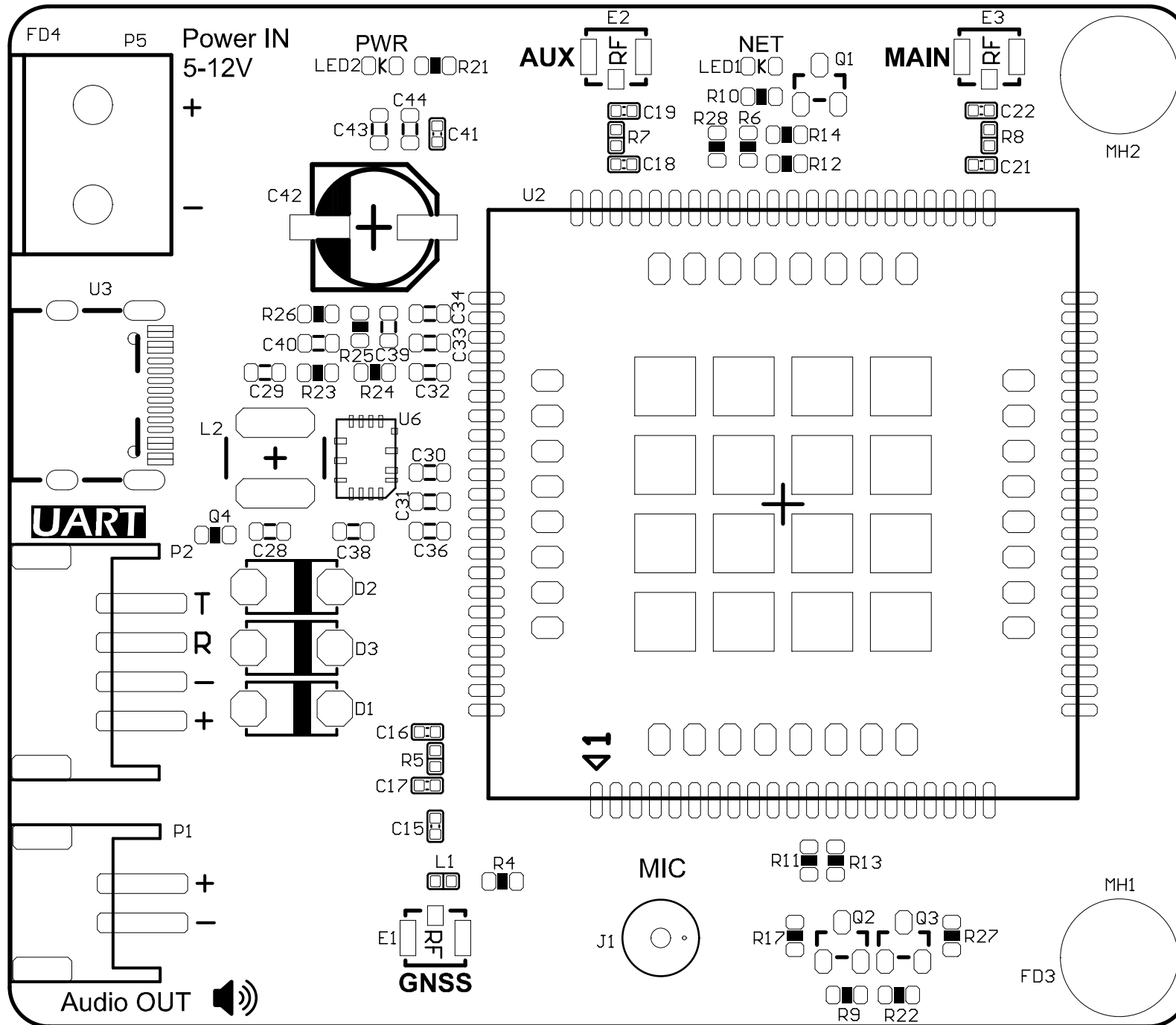

PCB Information		Name:[TEL0162 CAT4][V1.0.0]	Thickness: 1.6mm
Engineer: YXD	Top SolderMask: Black	Bottom SolderMask: Black	
Date: 20231031	Top Silkscreen: White	Bottom Silkscreen: White	

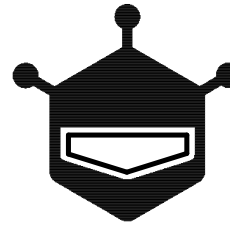

DFROBOT

SIM CARD

JP1

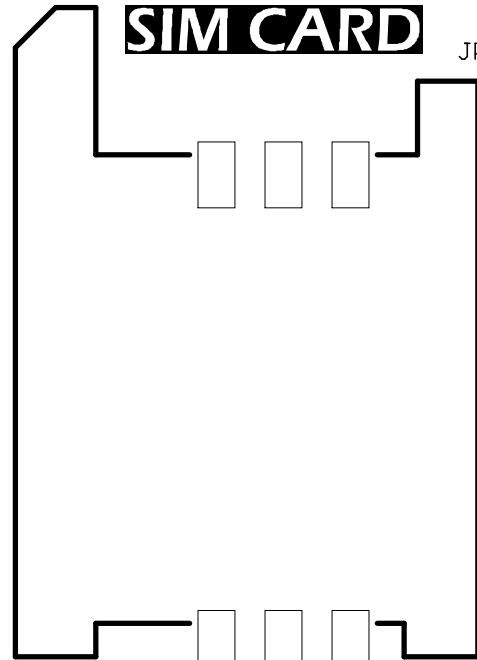

- T1
- T6
- T4
- T3
- T5
- T2

- R19
- Q5
- Q6
- R20

SIM7600G-H CAT4 4G Communication Module V1.0

PCB Information	Name:[TEL0162 CAT4][V1.0.0]	Thickness: 1.6mm
Engineer: YXD	Top SolderMask: Black	Bottom SolderMask: Black
Date: 20231031	Top Silkscreen: White	Bottom Silkscreen: White

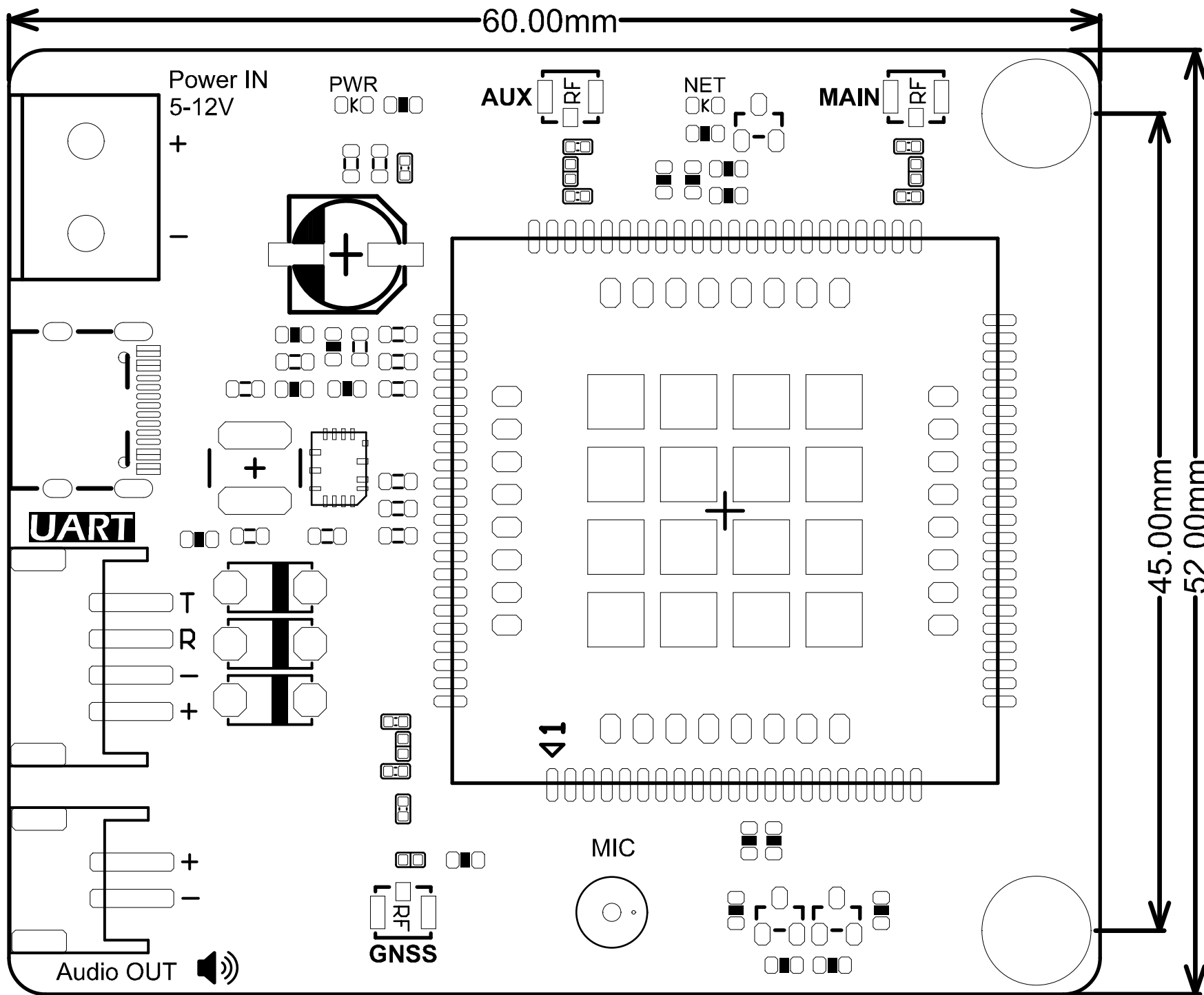

PCB Information		Name:[TEL0162 CAT4][V1.0.0]	Thickness: 1.6mm
Engineer: YXD	Top SolderMask: Black	Bottom SolderMask: Black	
Date: 20231031	Top Silkscreen: White	Bottom Silkscreen: White	

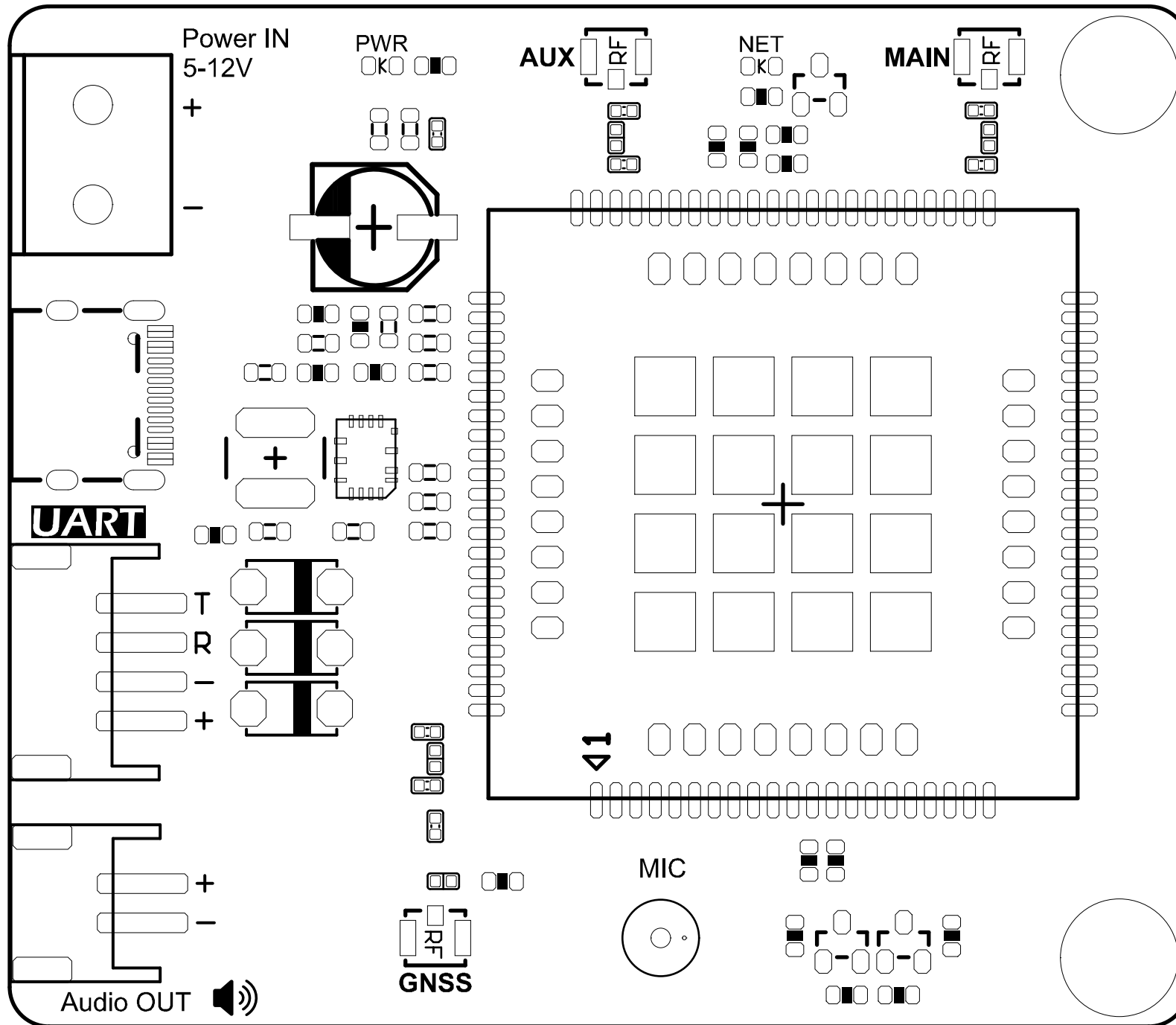

PCB Information		Name:[TEL0162 CAT4][V1.0.0]	Thickness: 1.6mm
Engineer: YXD	Top SolderMask: Black	Bottom SolderMask: Black	
Date: 20231031	Top Silkscreen: White	Bottom Silkscreen: White	

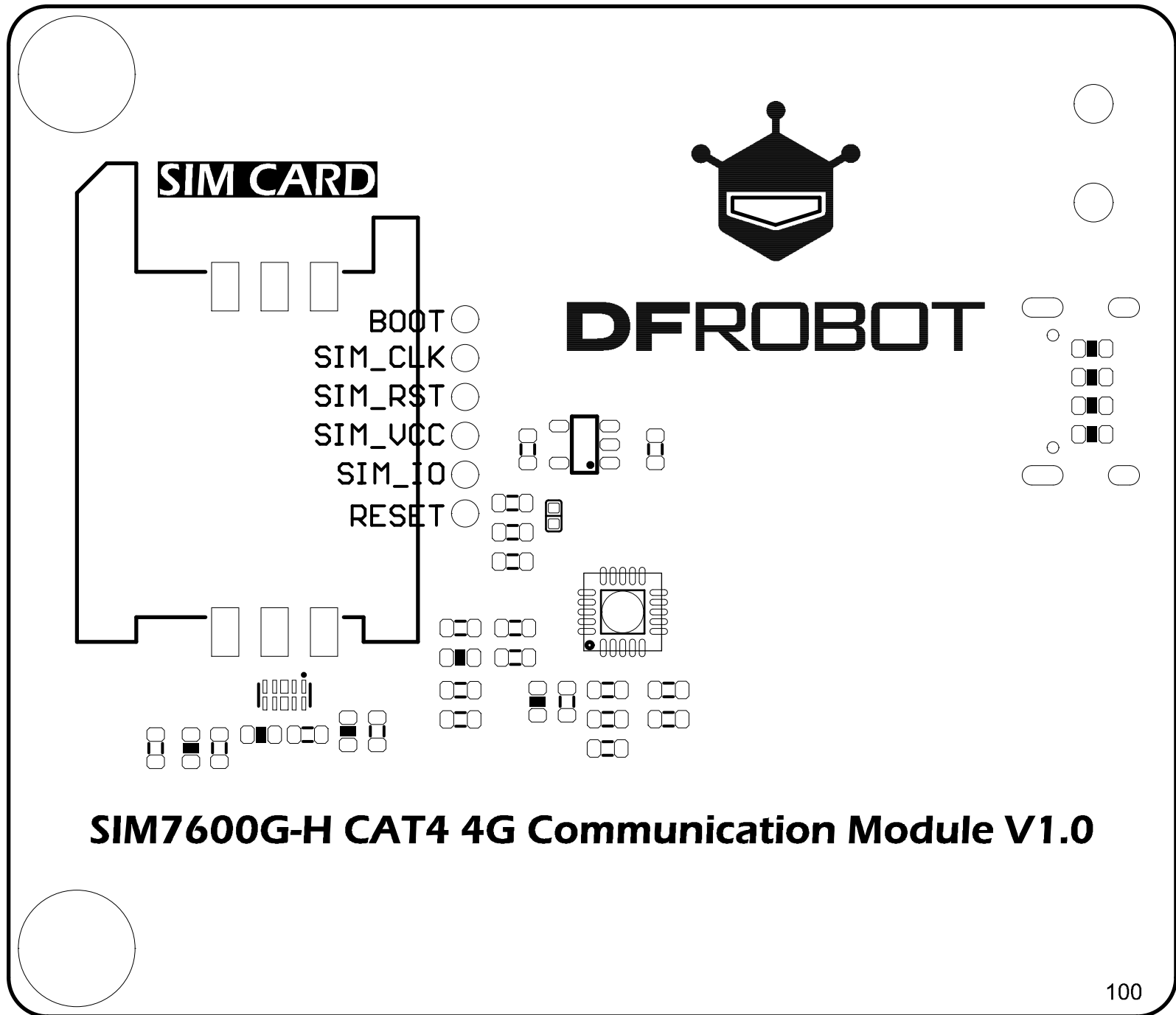

SIM7600G-H CAT4 4G Communication Module V1.0

PCB Information	Name:[TEL0162 CAT4][V1.0.0]	Thickness: 1.6mm
Engineer: YXD	Top SolderMask: Black	Bottom SolderMask: Black
Date: 20231031	Top Silkscreen: White	Bottom Silkscreen: White