

Title:	Gravity: Button module with RGB	Code:	DFR0991
Drawn:	Aaron-CD	Revision:	V1.0
Page:	1 of 1	Date:	2022/5/31
		Time:	9:57:12

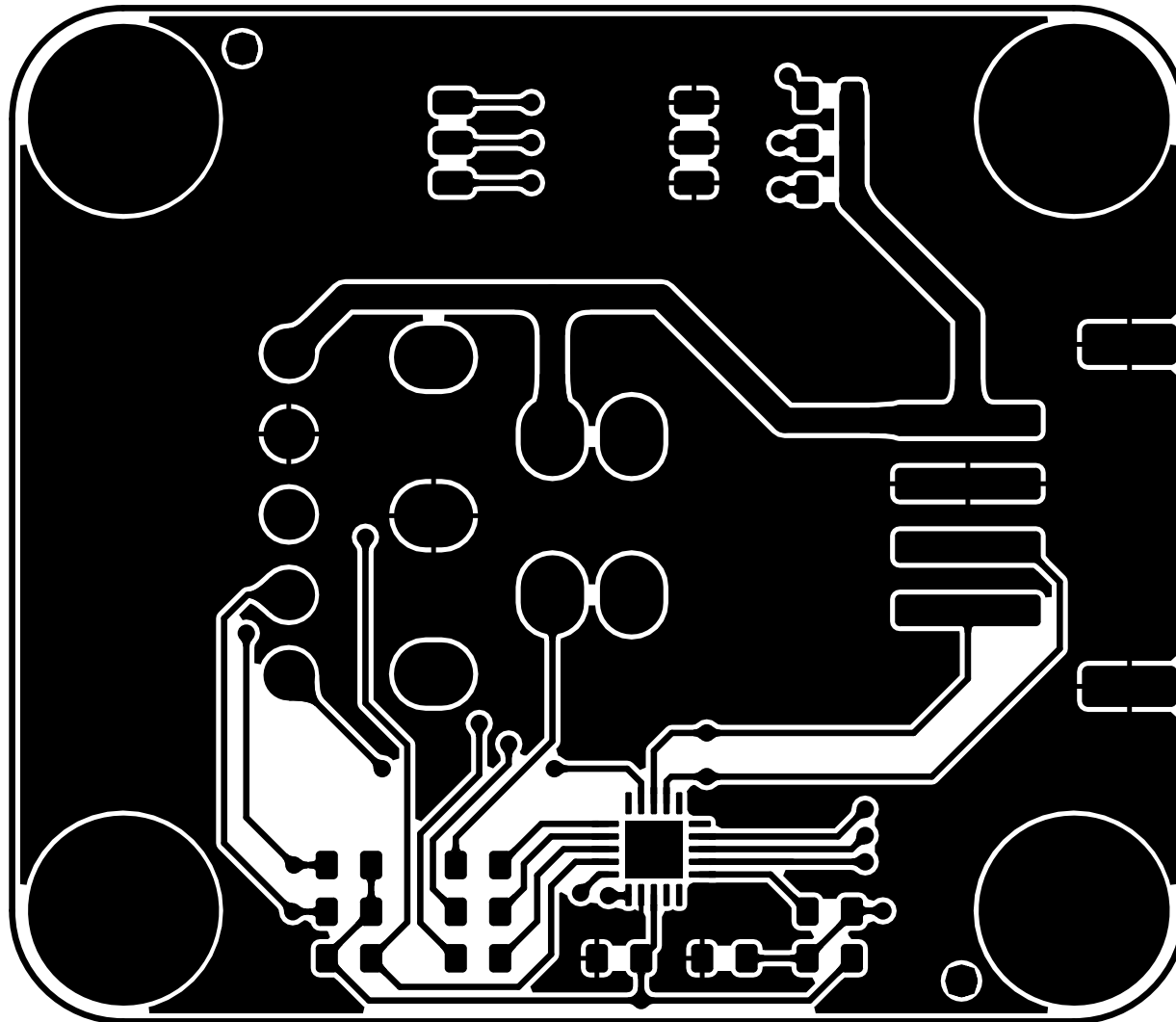

PCB Information	Name:[DFR0991](V0.0.2)	Thickness: 1.0mm
Engineer:Aaron	Top SolderMask: Black	Bottom SolderMask: Black
Date: 20220531	Top Silkscreen: White	Bottom Silkscreen: White

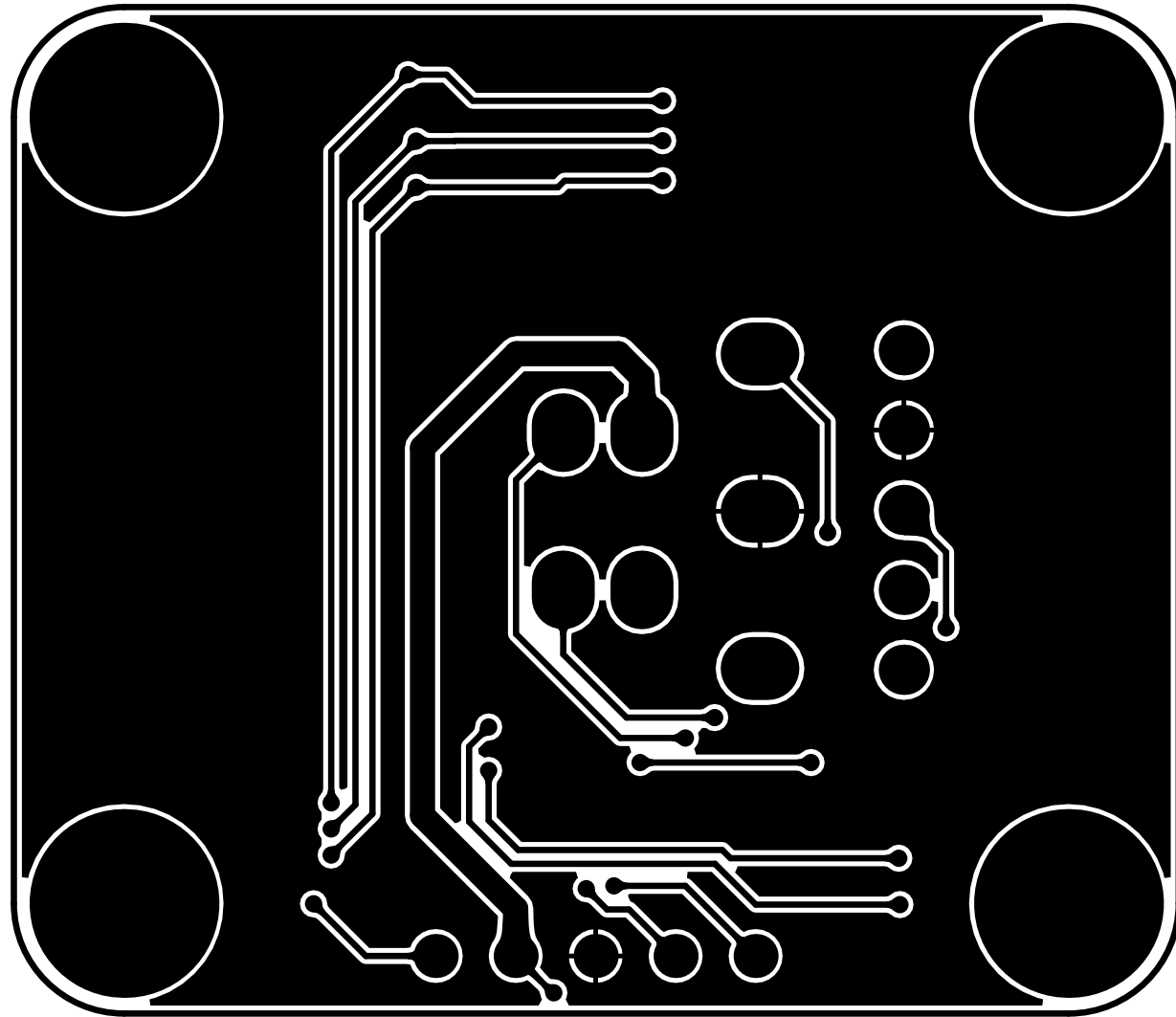

PCB Information	Name:[DFR0991](V0.0.2)	Thickness: 1.0mm
Engineer:Aaron	Top SolderMask: Black	Bottom SolderMask: Black
Date: 20220531	Top Silkscreen: White	Bottom Silkscreen: White

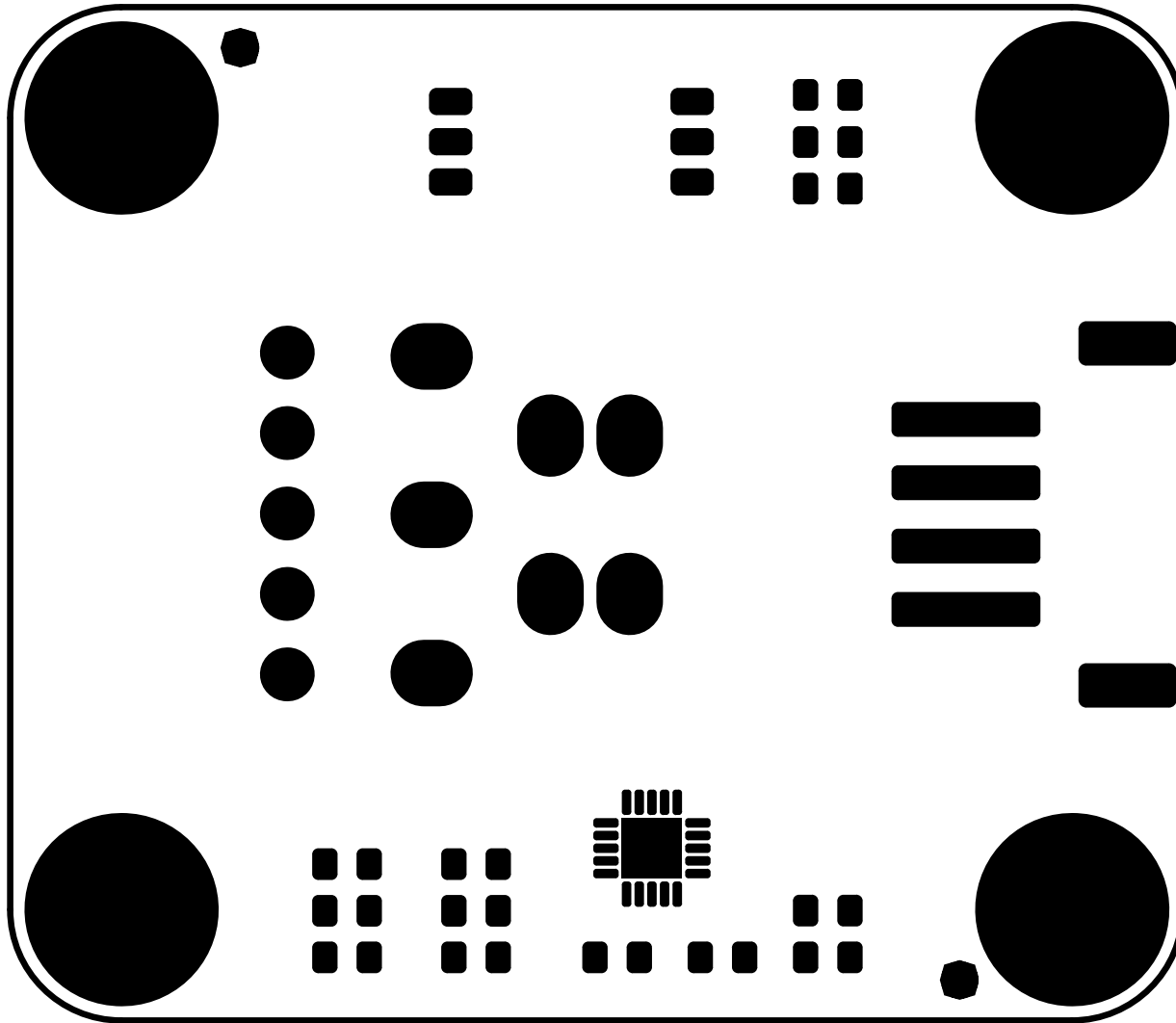

PCB Information	Name:[DFR0991](V0.0.2)	Thickness: 1.0mm
Engineer:Aaron	Top SolderMask: Black	Bottom SolderMask: Black
Date: 20220531	Top Silkscreen: White	Bottom Silkscreen: White

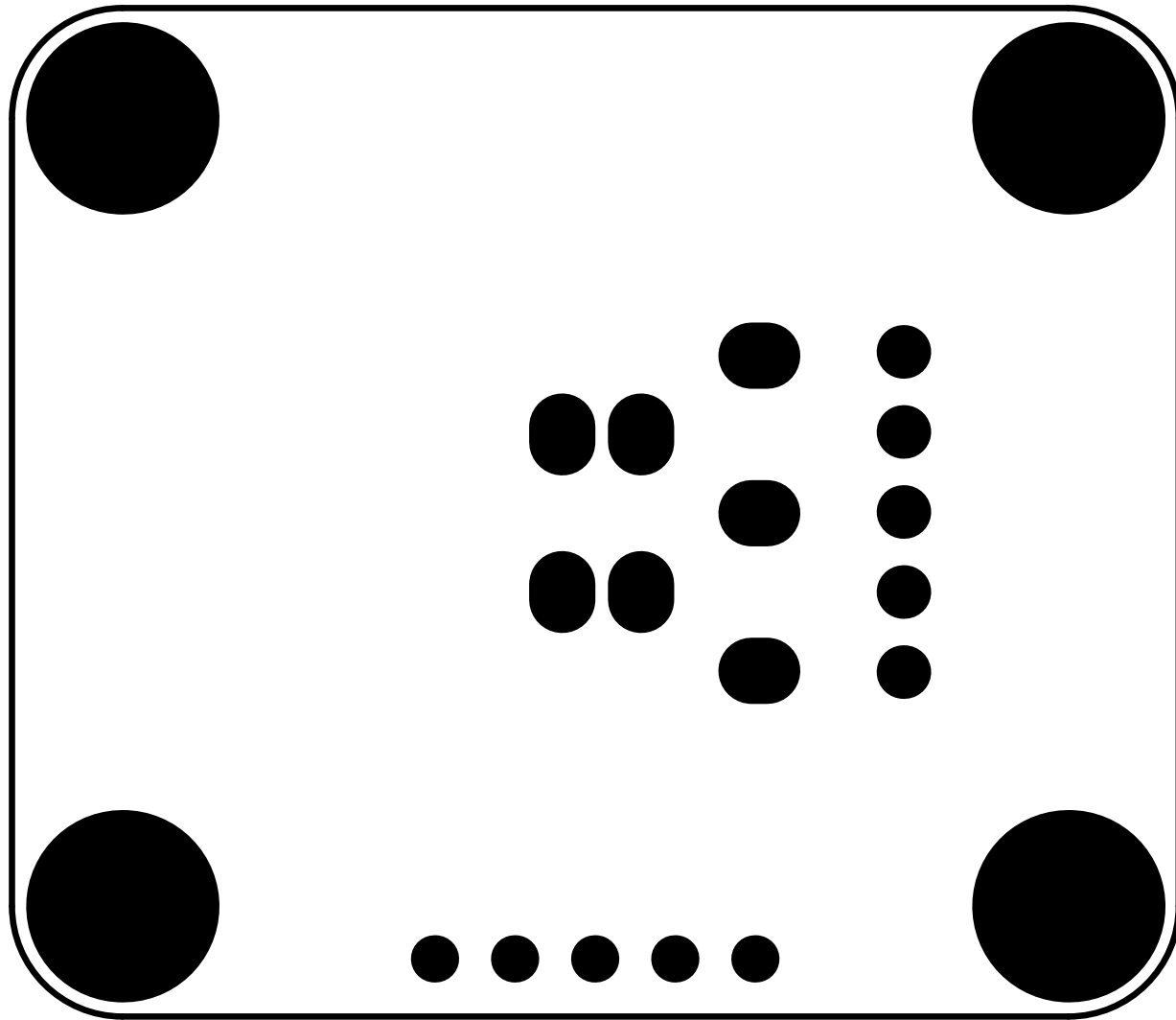

PCB Information	Name:[DFR0991](V0.0.2)	Thickness: 1.0mm
Engineer:Aaron	Top SolderMask: Black	Bottom SolderMask: Black
Date: 20220531	Top Silkscreen: White	Bottom Silkscreen: White

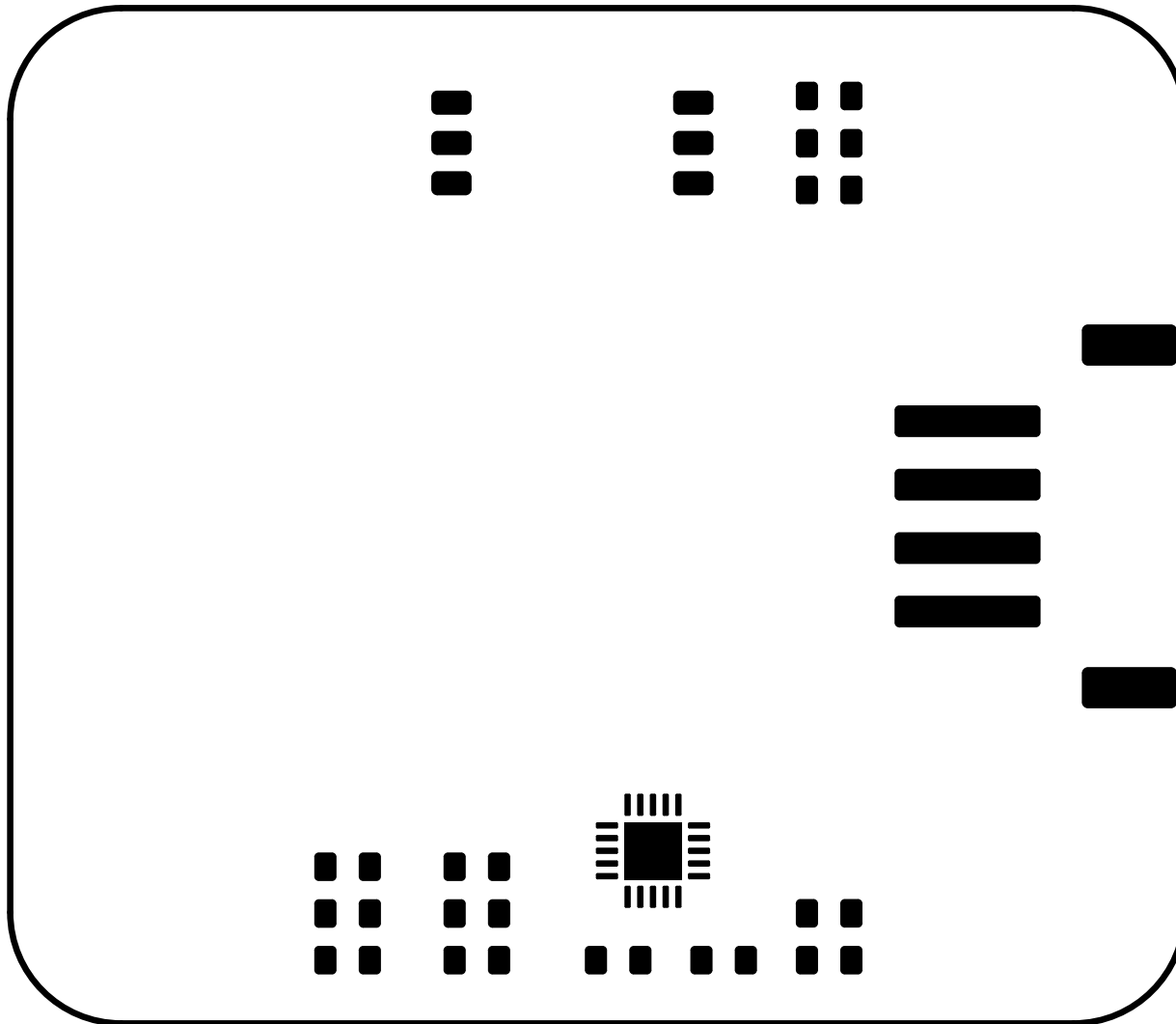

PCB Information	Name:[DFR0991](V0.0.2)	Thickness: 1.0mm
Engineer:Aaron	Top SolderMask: Black	Bottom SolderMask: Black
Date: 20220531	Top Silkscreen: White	Bottom Silkscreen: White

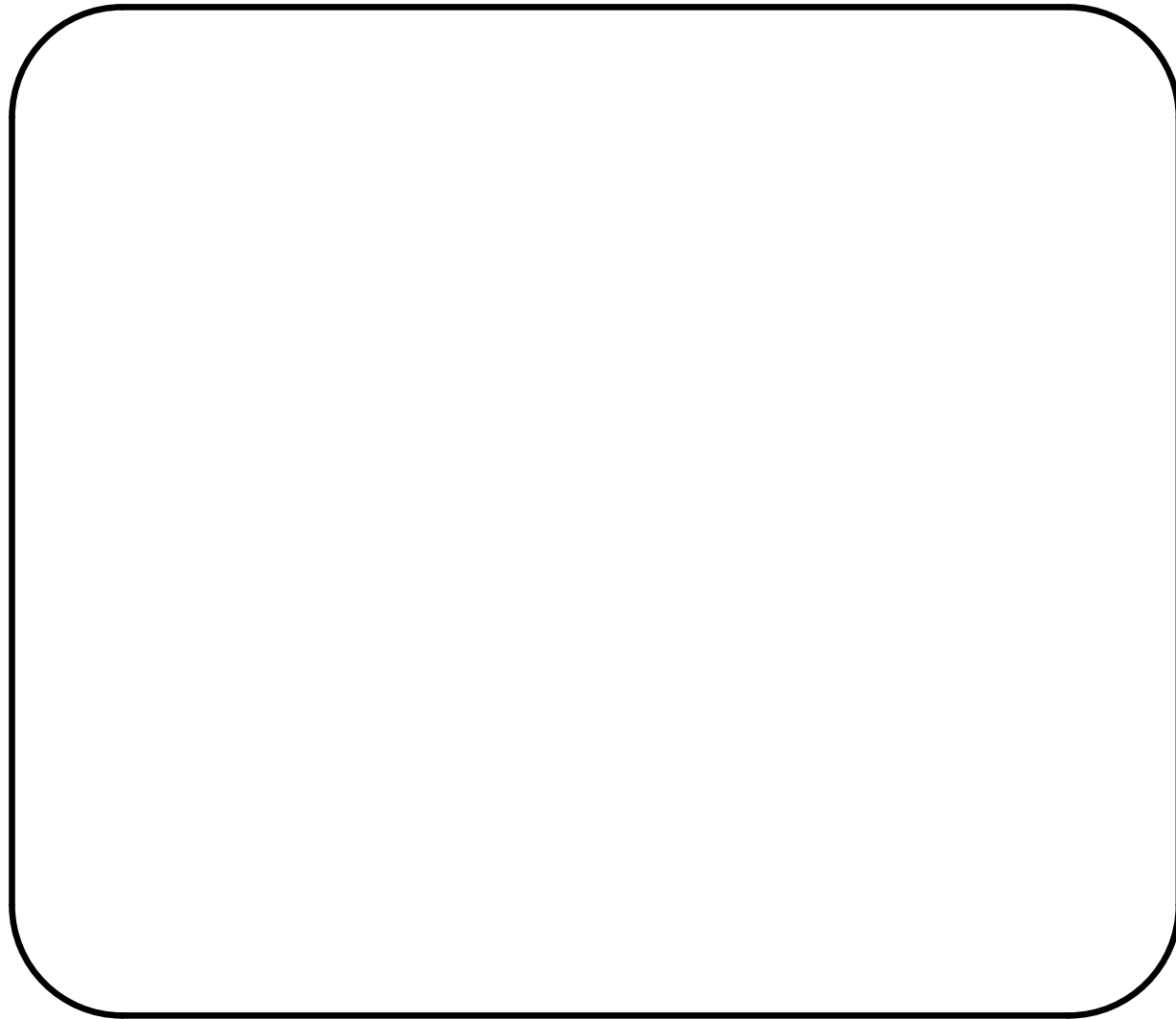

PCB Information	Name:[DFR0991](V0.0.2)	Thickness: 1.0mm
Engineer:Aaron	Top SolderMask: Black	Bottom SolderMask: Black
Date: 20220531	Top Silkscreen: White	Bottom Silkscreen: White

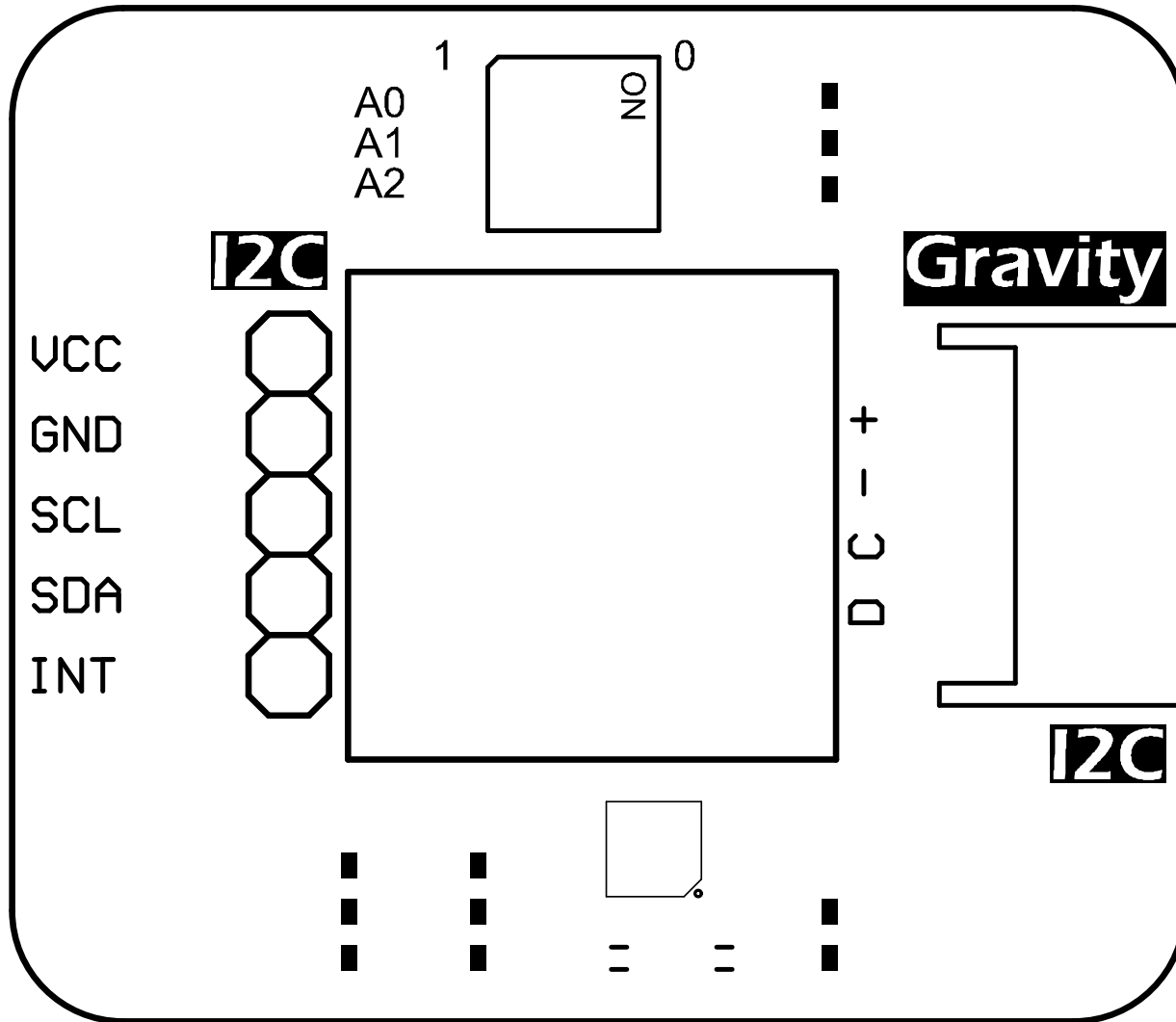

PCB Information	Name:[DFR0991](V0.0.2)	Thickness: 1.0mm
Engineer:Aaron	Top SolderMask: Black	Bottom SolderMask: Black
Date: 20220531	Top Silkscreen: White	Bottom Silkscreen: White

Button module with RGB
V1.0

A2	A1	A0	ADDR
0	0	0	0X23
0	0	1	0X24
0	1	0	0X25
0	1	1	0X26
1	0	0	0X27
1	0	1	0X28
1	1	0	0X29
1	1	1	0X2A



002

PCB Information	Name:[DFR0991](V0.0.2)	Thickness: 1.0mm
Engineer:Aaron	Top SolderMask: Black	Bottom SolderMask: Black
Date: 20220531	Top Silkscreen: White	Bottom Silkscreen: White

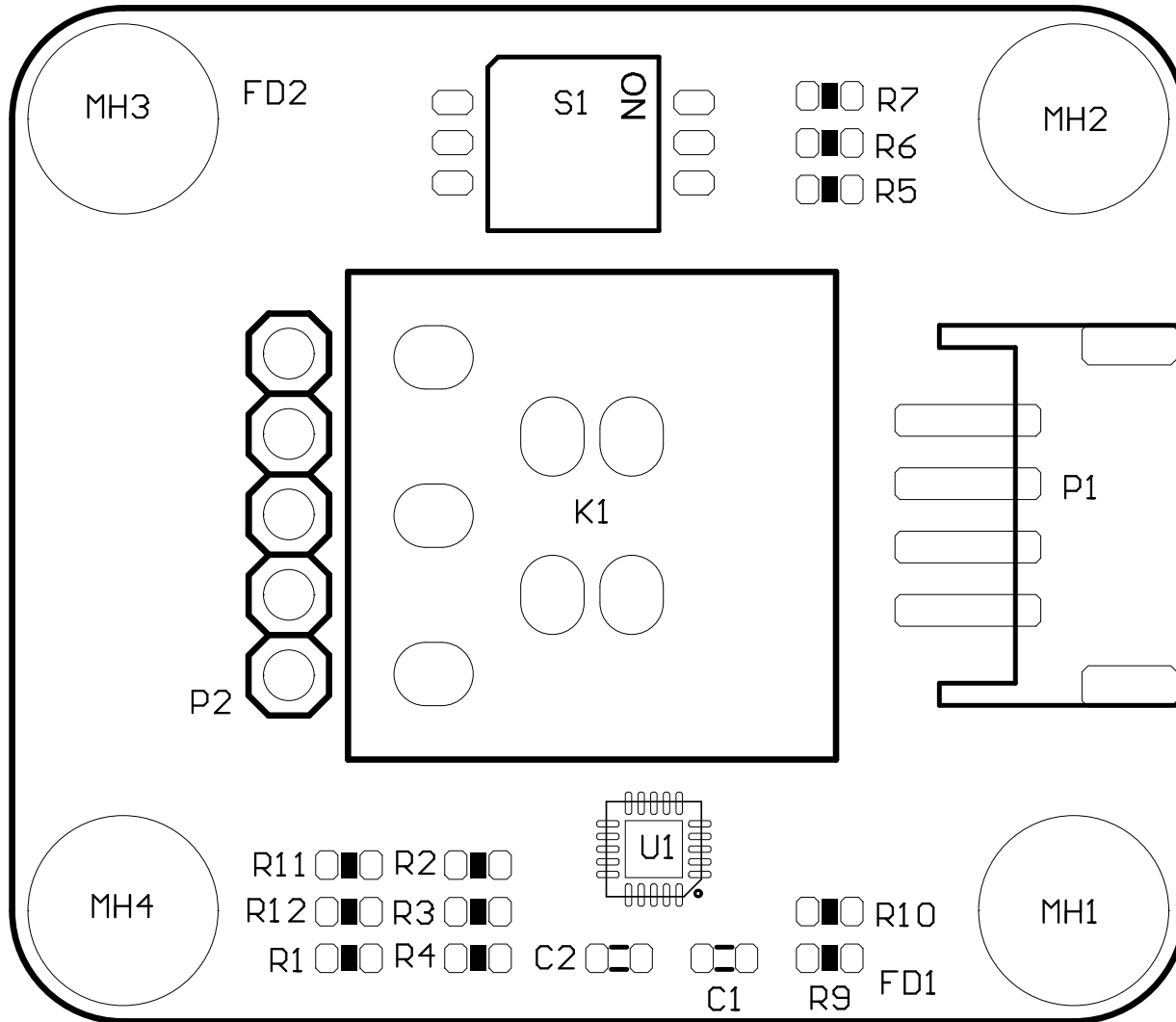

PCB Information	Name:[DFR0991](V0.0.2)	Thickness: 1.0mm
Engineer:Aaron	Top SolderMask: Black	Bottom SolderMask: Black
Date: 20220531	Top Silkscreen: White	Bottom Silkscreen: White

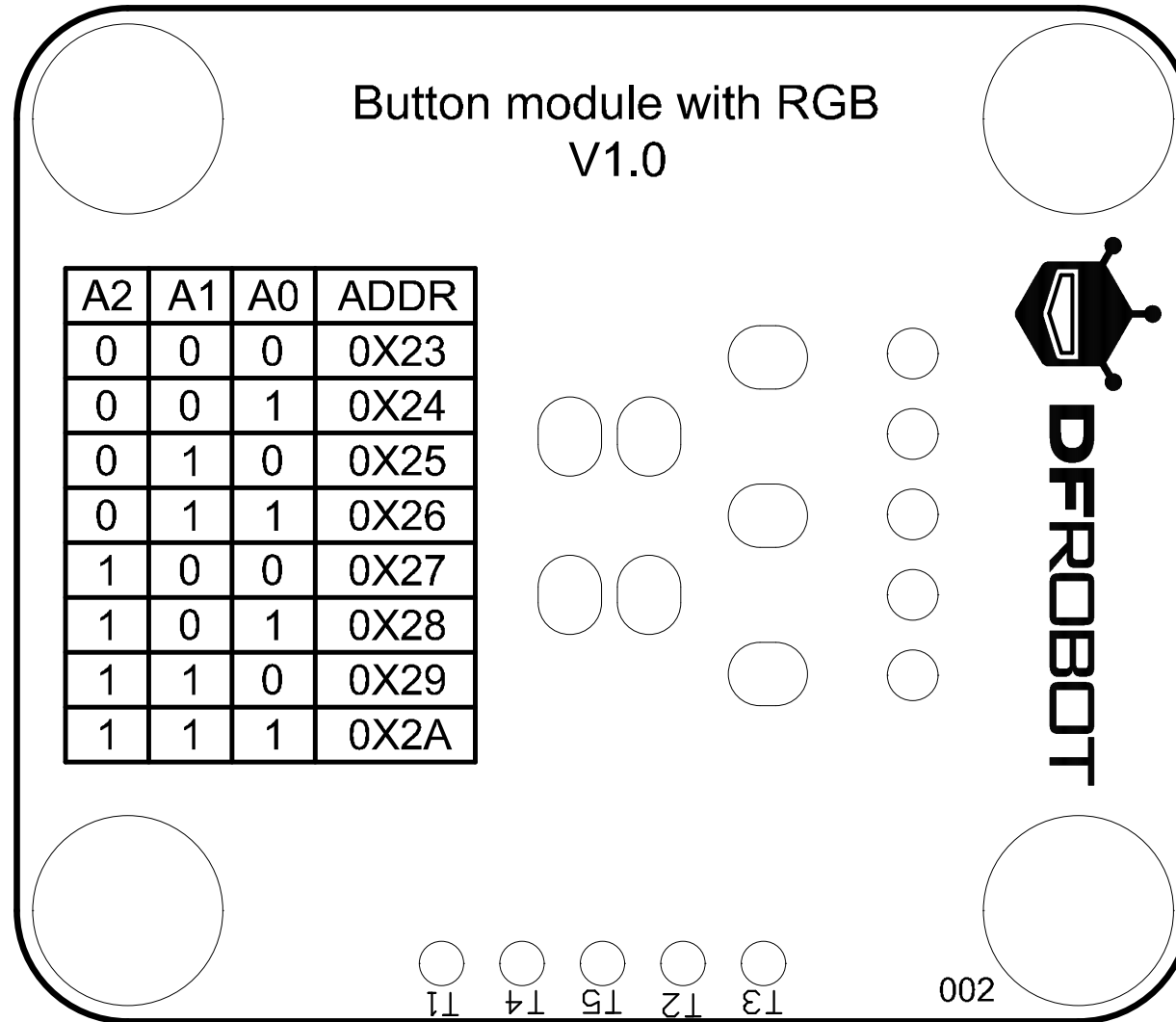

PCB Information	Name:[DFR0991](V0.0.2)	Thickness: 1.0mm
Engineer:Aaron	Top SolderMask: Black	Bottom SolderMask: Black
Date: 20220531	Top Silkscreen: White	Bottom Silkscreen: White

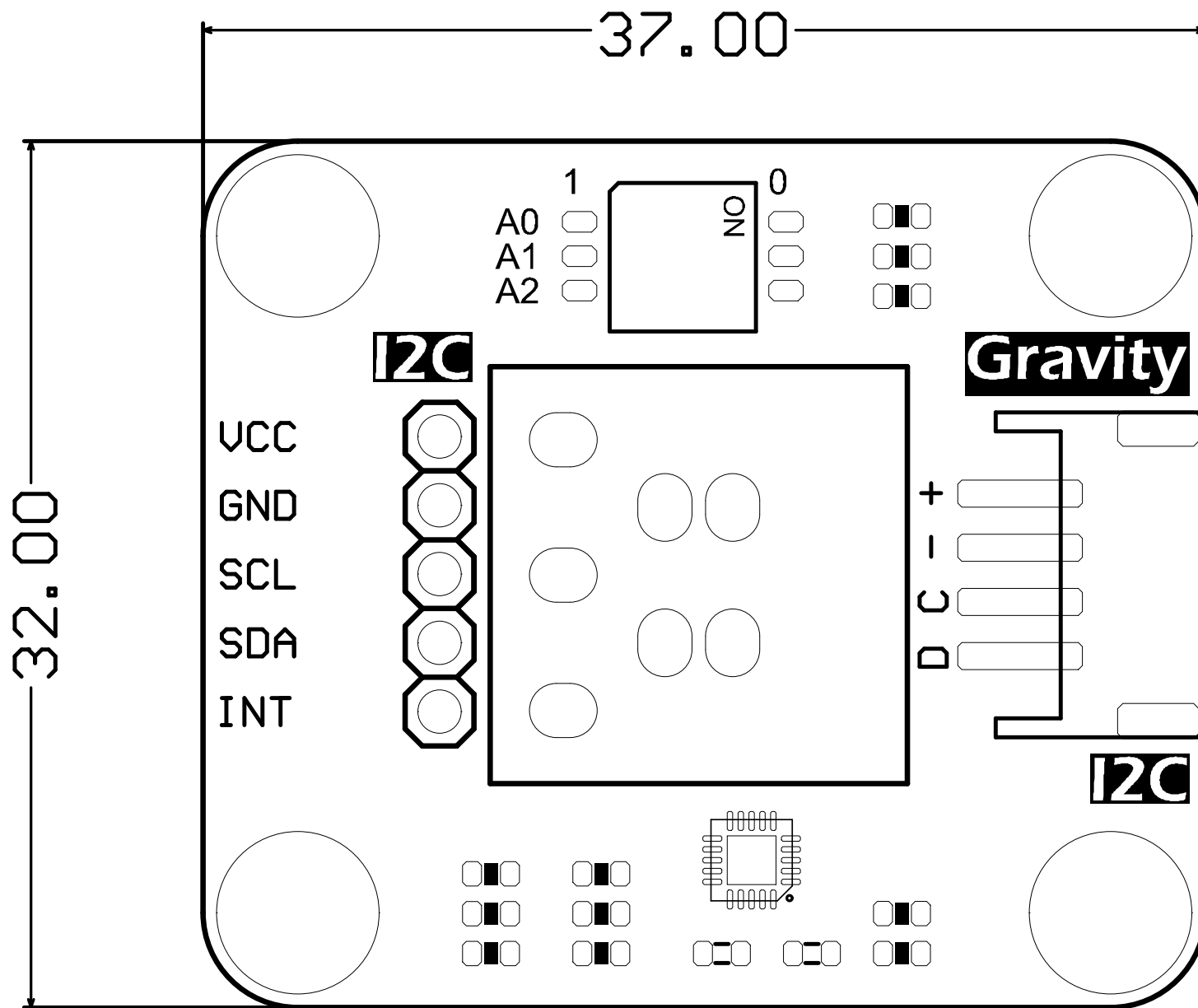

PCB Information	Name:[DFR0991](V0.0.2)	Thickness: 1.0mm
Engineer:Aaron	Top SolderMask: Black	Bottom SolderMask: Black
Date: 20220531	Top Silkscreen: White	Bottom Silkscreen: White

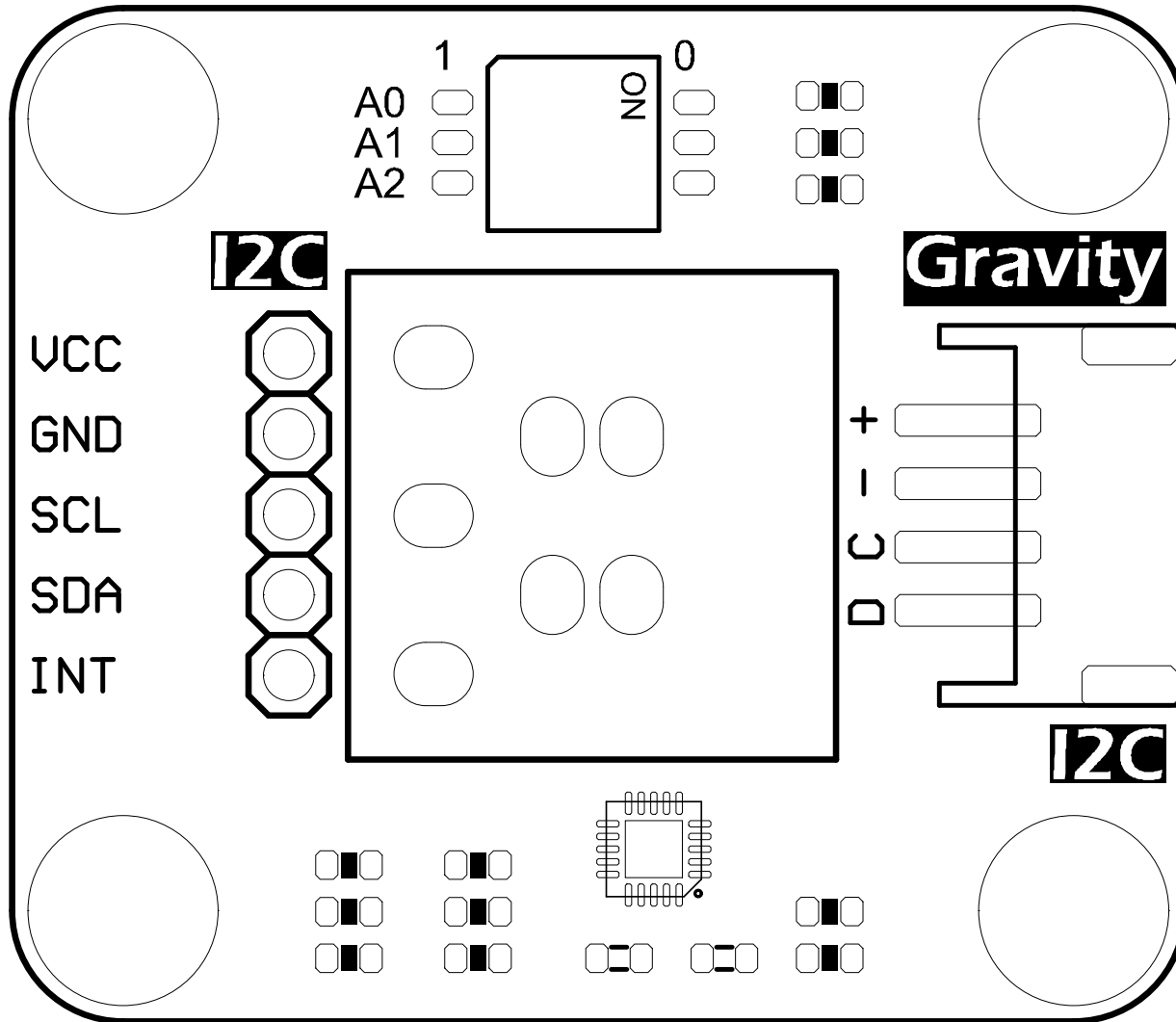

PCB Information	Name:[DFR0991](V0.0.2)	Thickness: 1.0mm
Engineer:Aaron	Top SolderMask: Black	Bottom SolderMask: Black
Date: 20220531	Top Silkscreen: White	Bottom Silkscreen: White

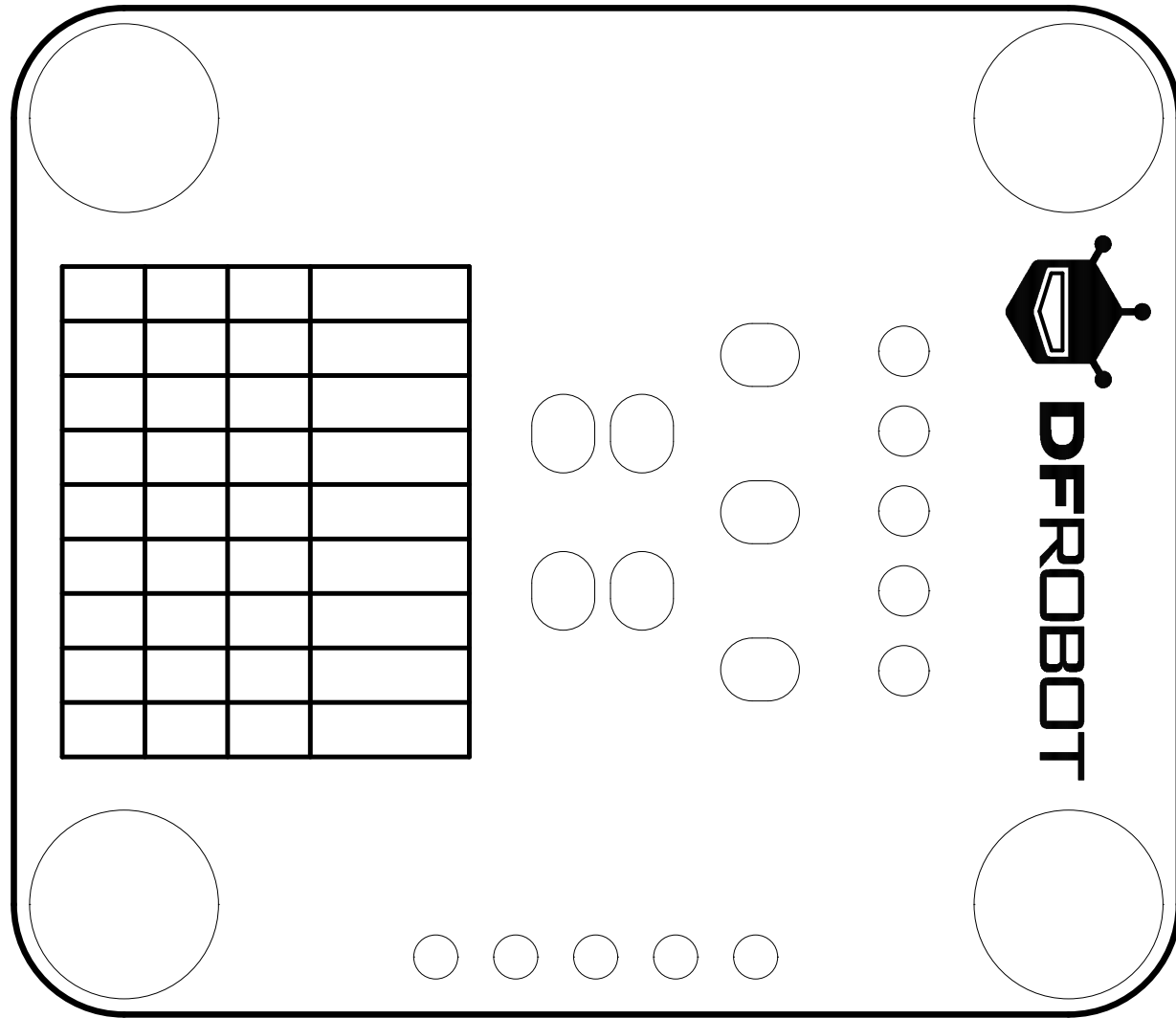

PCB Information	Name:[DFR0991](V0.0.2)	Thickness: 1.0mm
Engineer:Aaron	Top SolderMask: Black	Bottom SolderMask: Black
Date: 20220531	Top Silkscreen: White	Bottom Silkscreen: White