

PICO插座

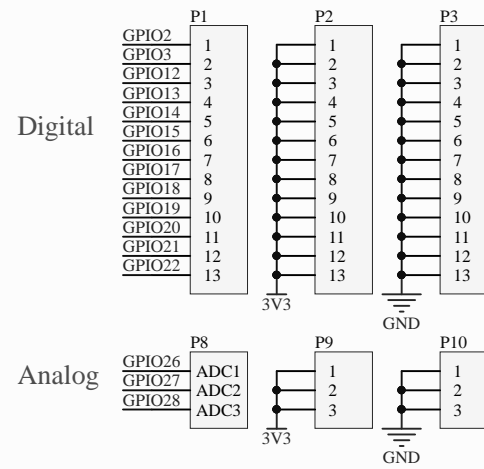

IO扩展口

UART

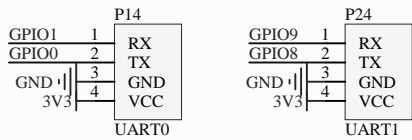

SPI

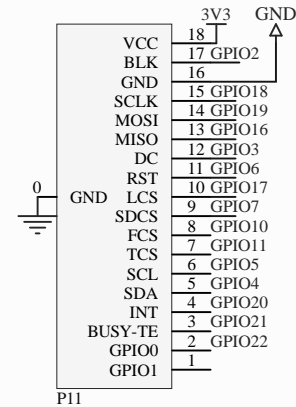
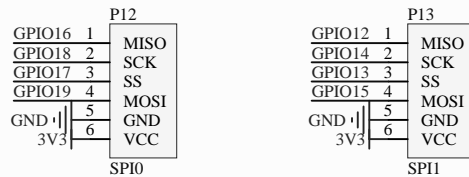

GDI接口

相对上一版本改动：
更改外设引脚映射，与官方的库保持一致

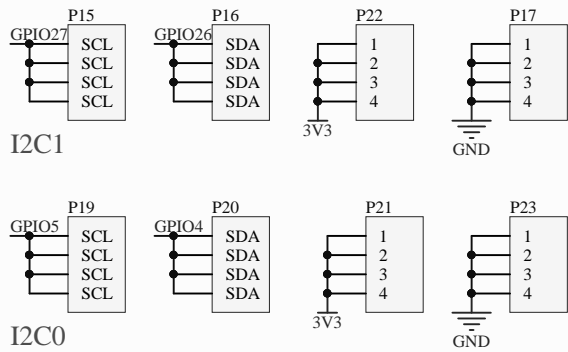

I2C0

I2C1

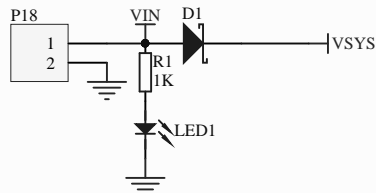

300



Title: Pico Gravity Shield	Code: DFR0848
Drawn: Roker-CD	Revision: V3.0.0
Page: 1 of 1	Date: 2022/8/15/周一
	Time: 14:13:26

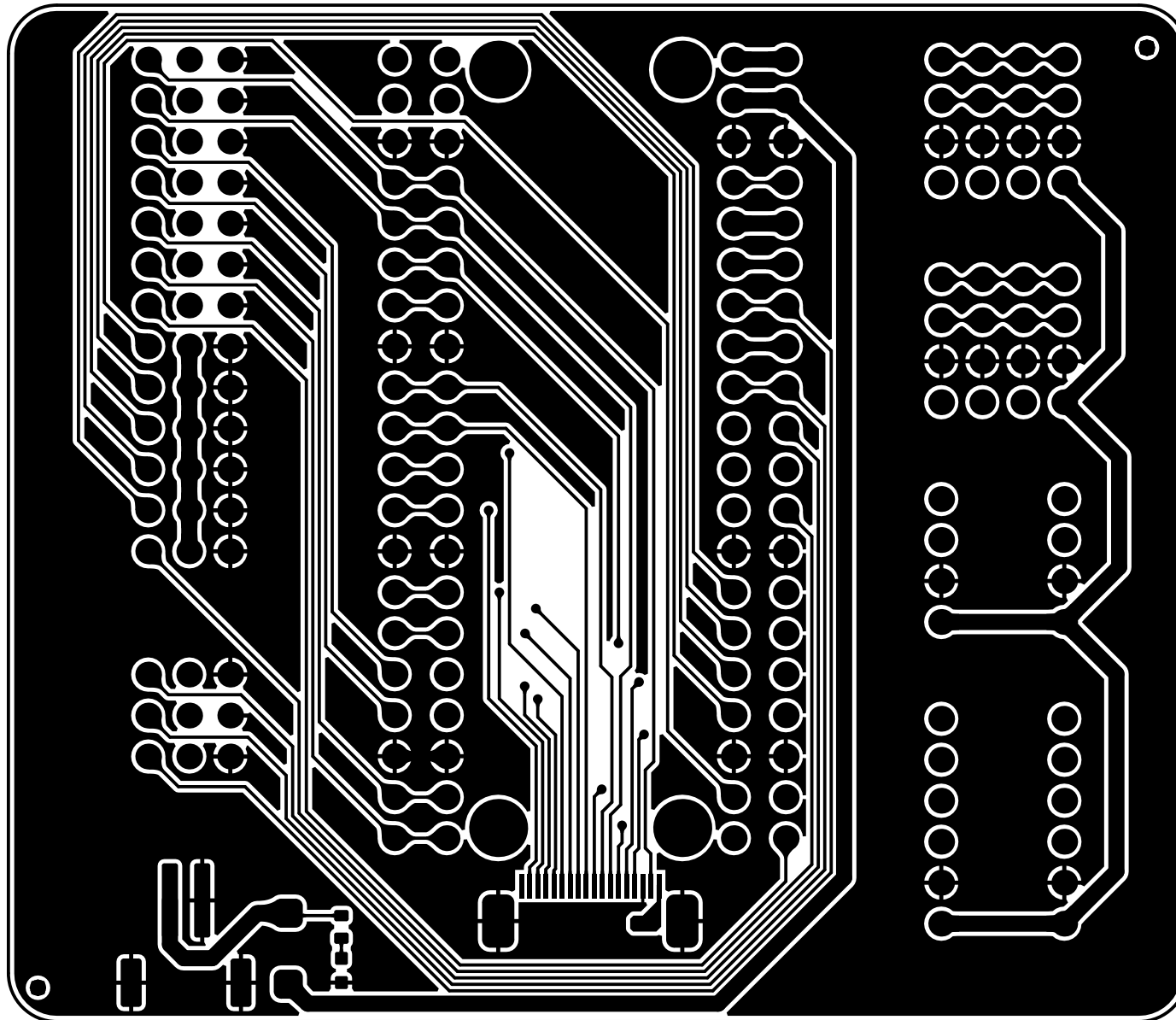

PCB Information	Name:DFR0848[V3.0.0]	Thickness: 1.6mm
Engineer:Roker	Top SolderMask: Black	Bottom SolderMask: Black
Date:20220815	Top Silkscreen: White	Bottom Silkscreen: White

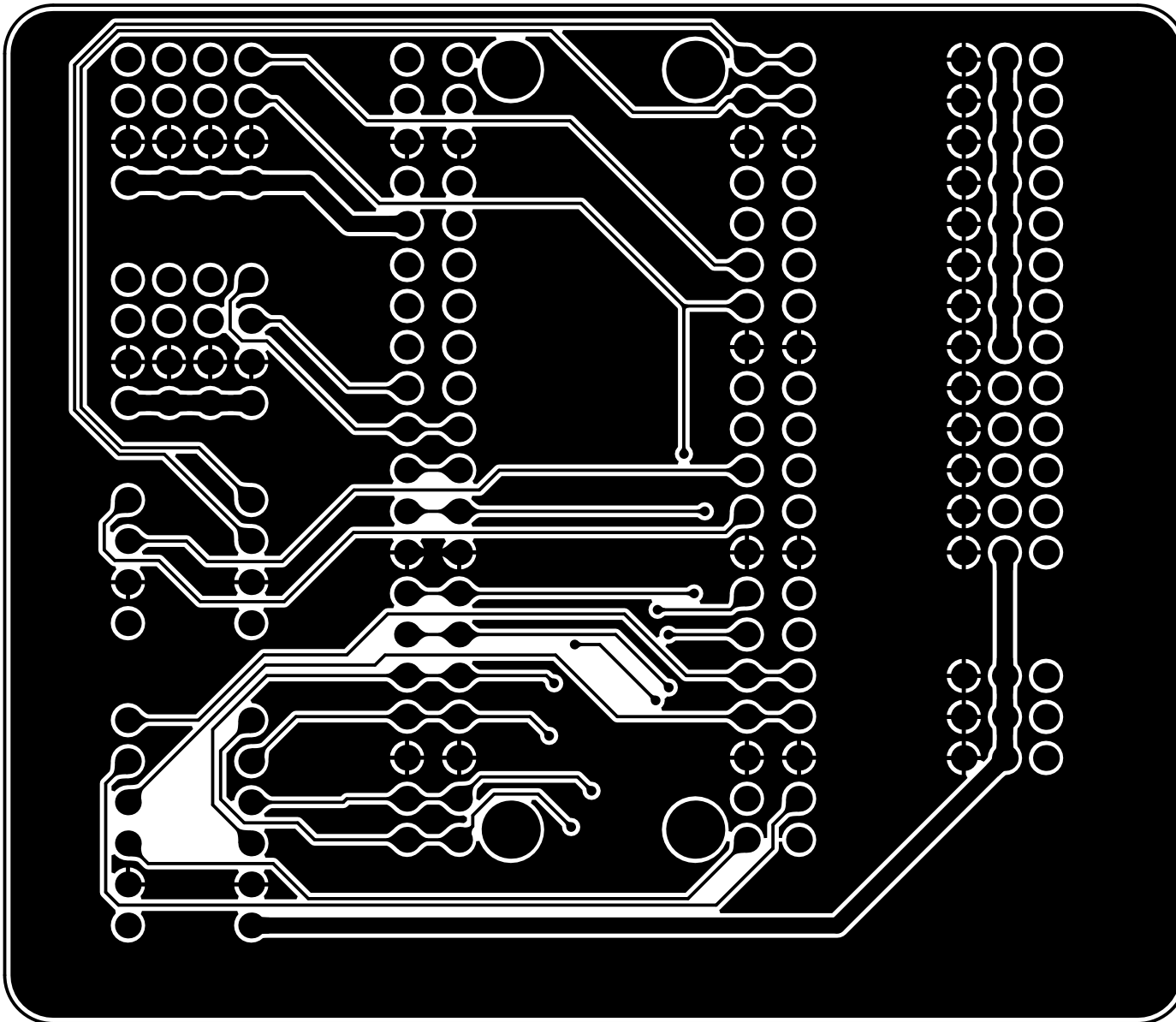

PCB Information	Name:DFR0848[V3.0.0]	Thickness: 1.6mm
Engineer:Roker	Top SolderMask: Black	Bottom SolderMask: Black
Date:20220815	Top Silkscreen: White	Bottom Silkscreen: White

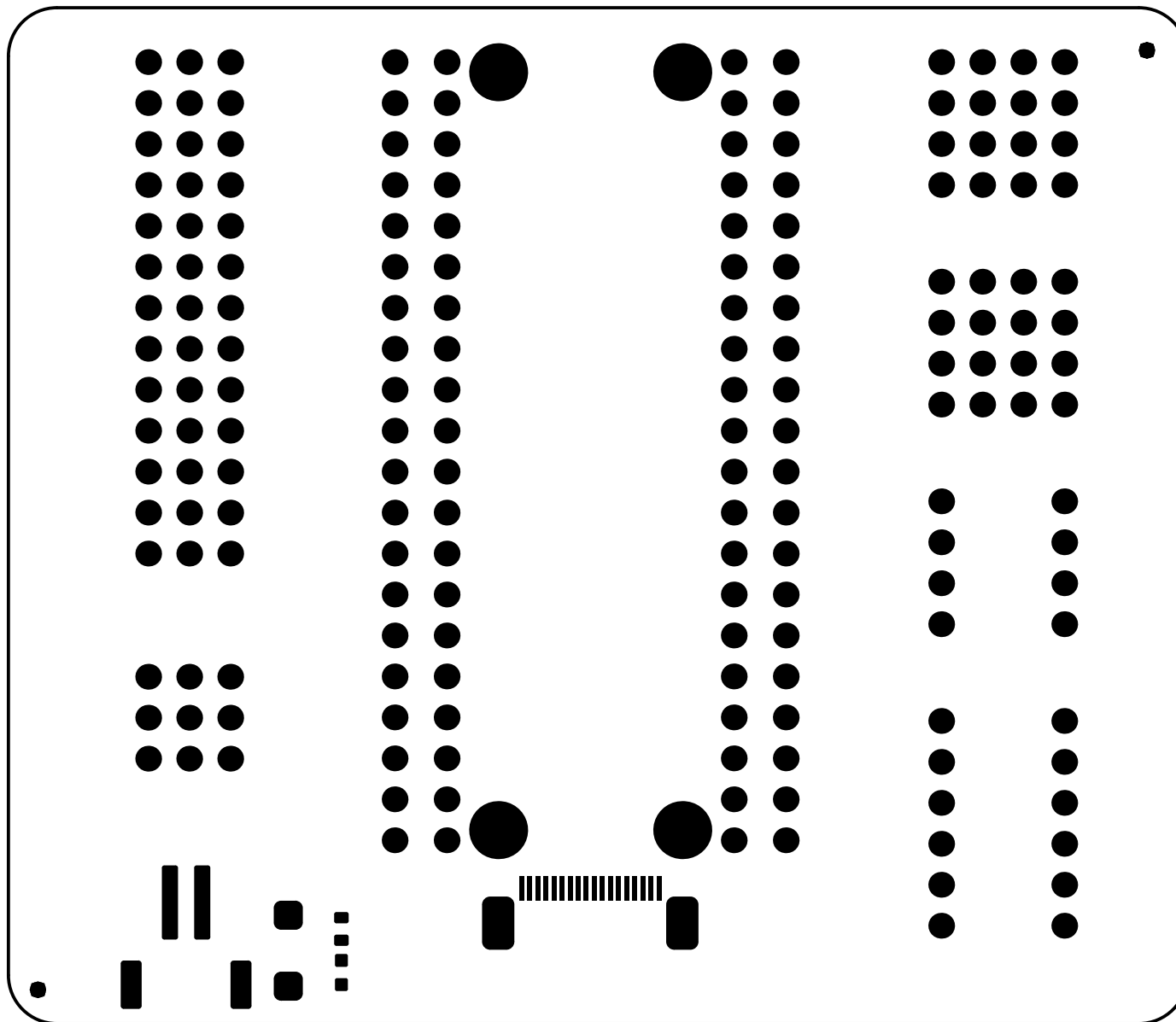

PCB Information	Name:DFR0848[V3.0.0]	Thickness: 1.6mm
Engineer:Roker	Top SolderMask: Black	Bottom SolderMask: Black
Date:20220815	Top Silkscreen: White	Bottom Silkscreen: White

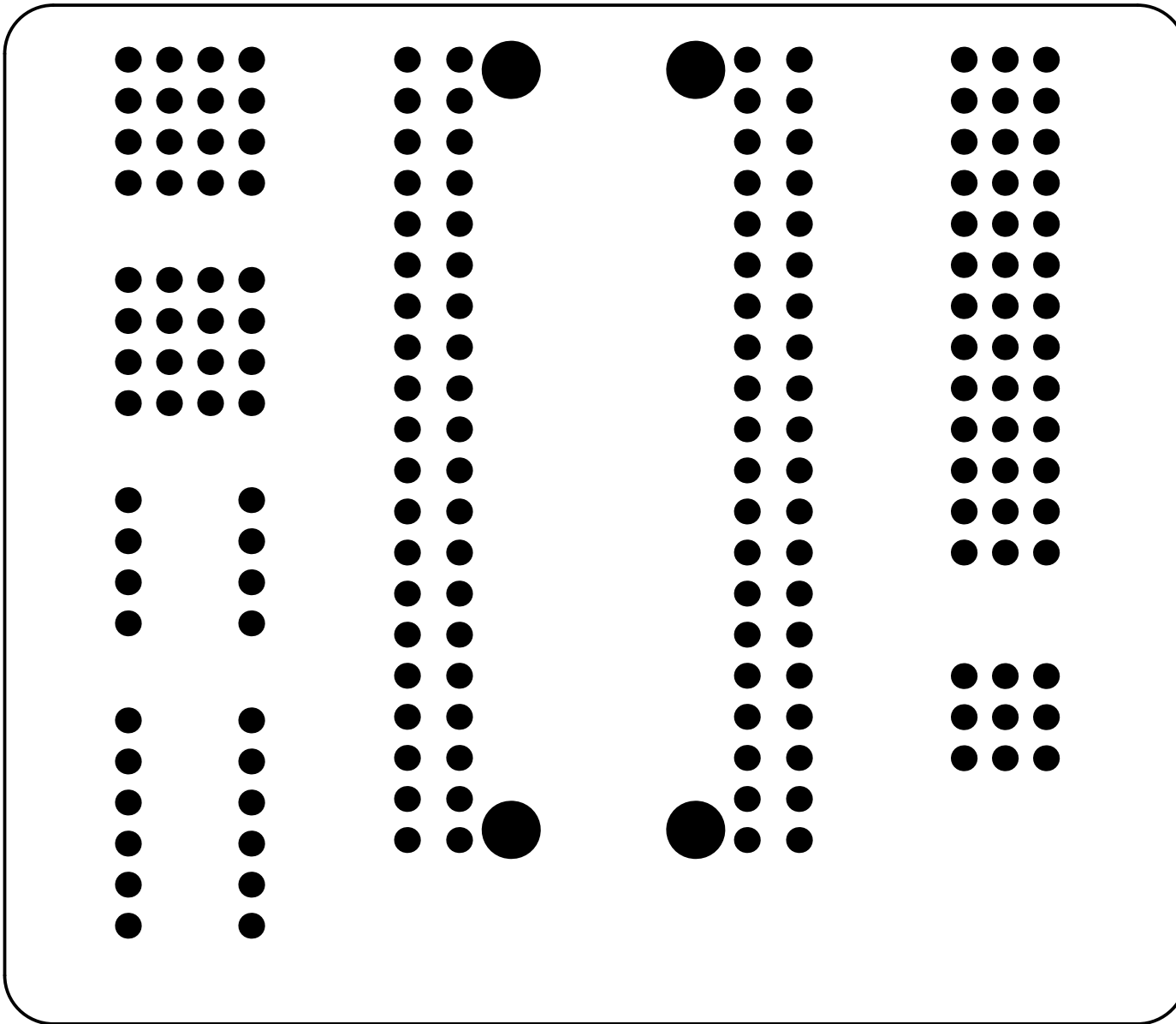

PCB Information	Name:DFR0848[V3.0.0]	Thickness: 1.6mm
Engineer:Roker	Top SolderMask: Black	Bottom SolderMask: Black
Date:20220815	Top Silkscreen: White	Bottom Silkscreen: White

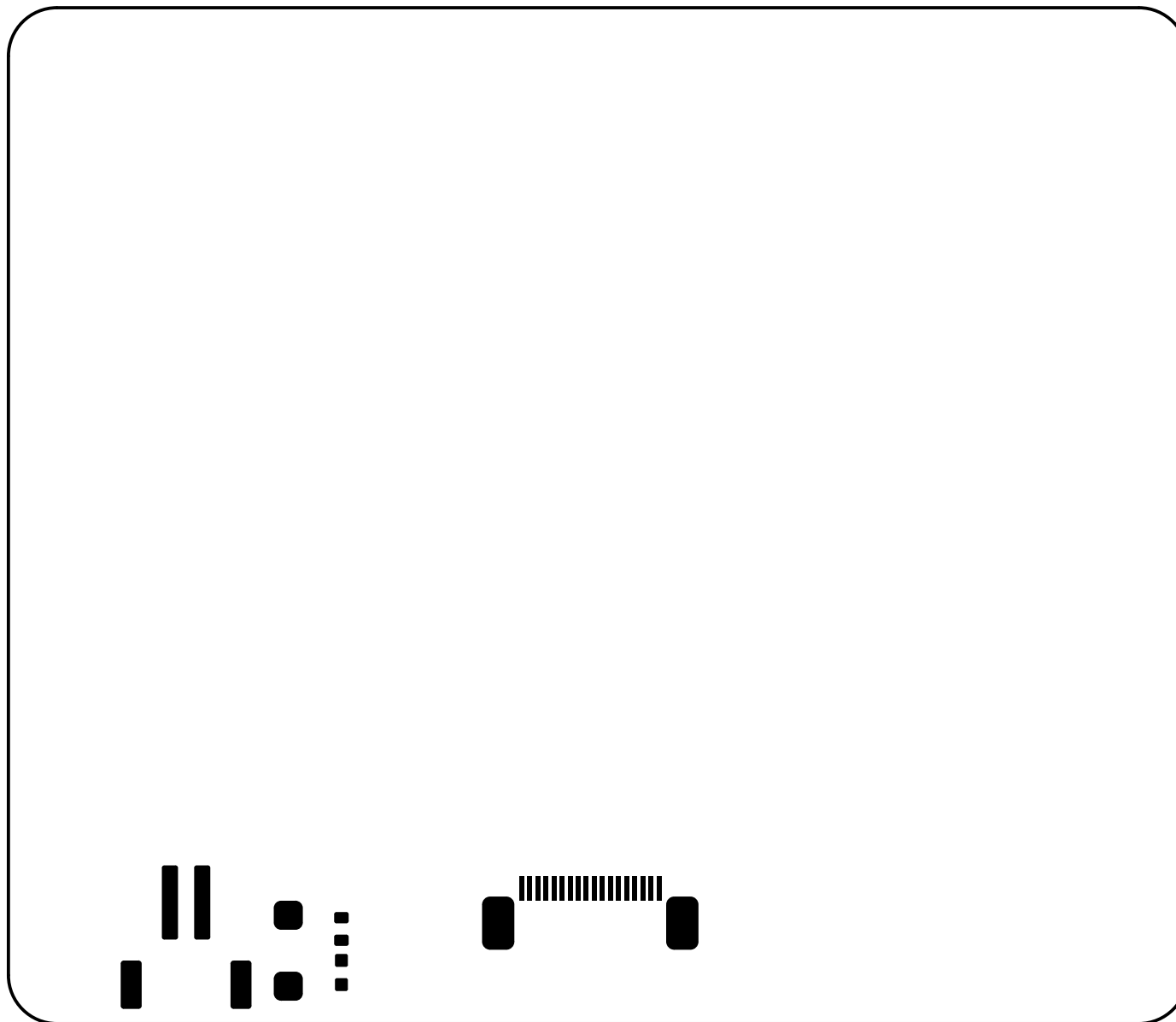

PCB Information	Name:DFR0848[V3.0.0]	Thickness: 1.6mm
Engineer:Roker	Top SolderMask: Black	Bottom SolderMask: Black
Date:20220815	Top Silkscreen: White	Bottom Silkscreen: White

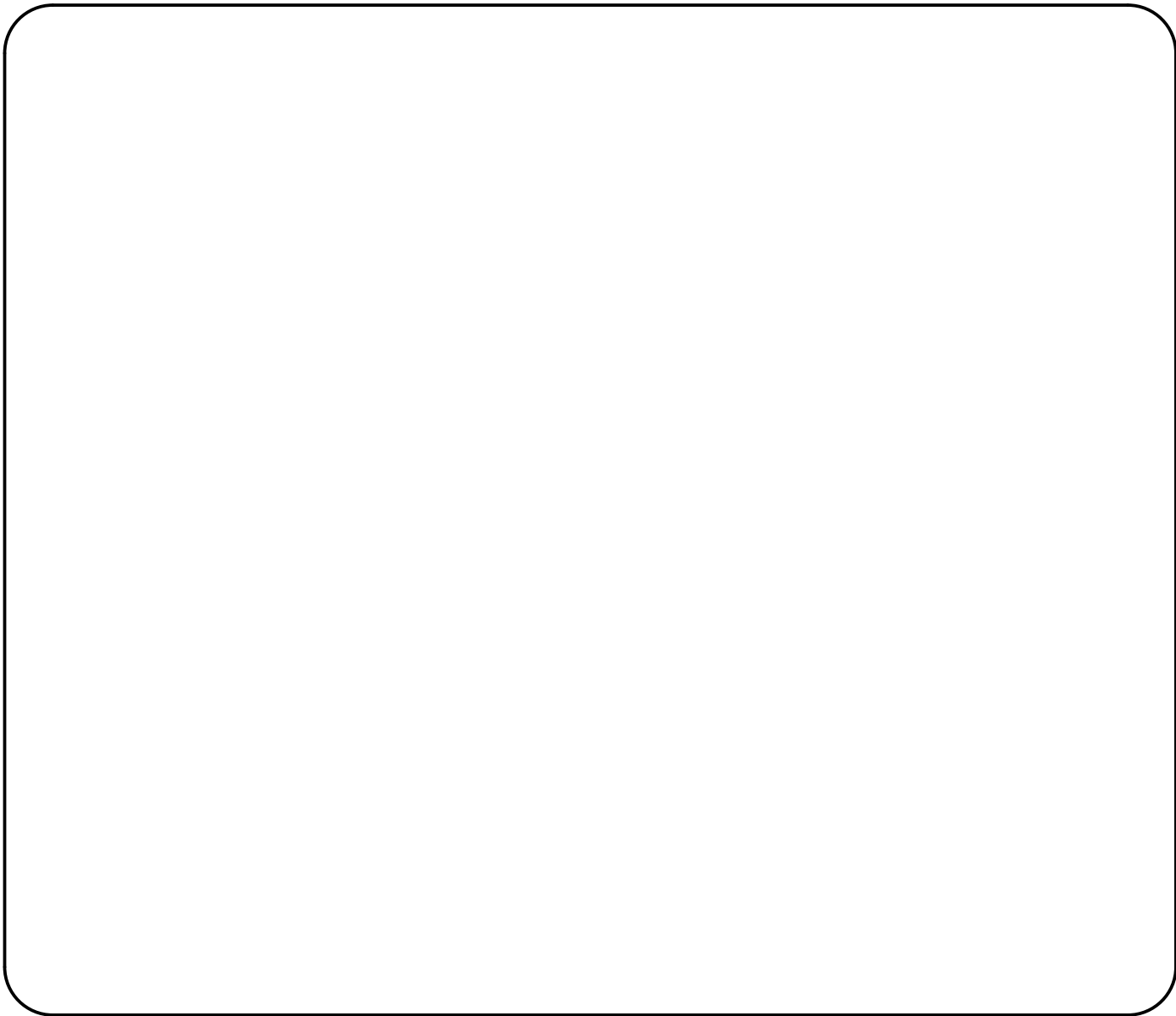

PCB Information	Name:DFR0848[V3.0.0]	Thickness: 1.6mm
Engineer:Roker	Top SolderMask: Black	Bottom SolderMask: Black
Date:20220815	Top Silkscreen: White	Bottom Silkscreen: White

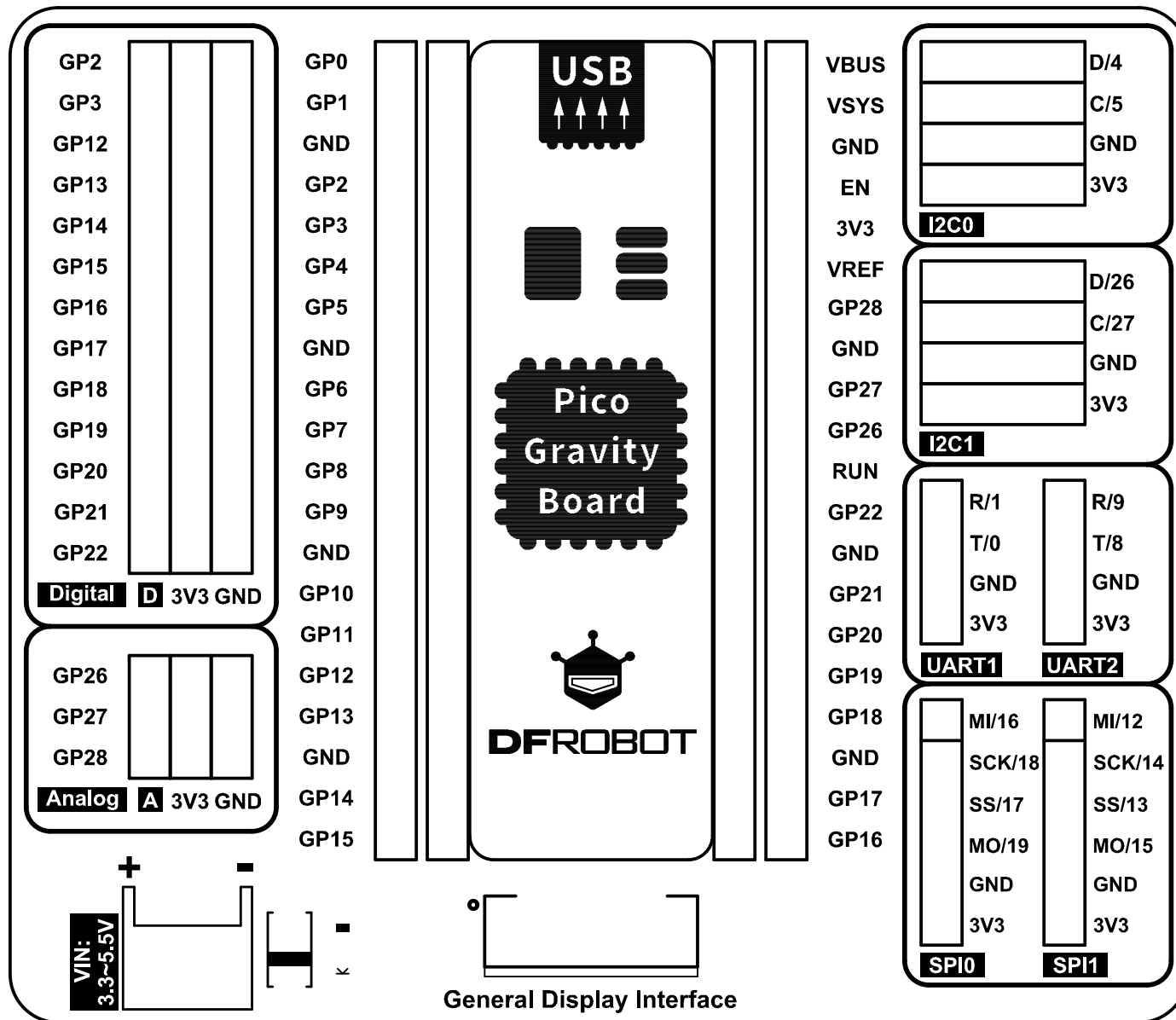

PCB Information	Name:DFR0848[V3.0.0]	Thickness: 1.6mm
Engineer:Roker	Top SolderMask: Black	Bottom SolderMask: Black
Date:20220815	Top Silkscreen: White	Bottom Silkscreen: White



300

Pico Gravity Board(V3.0)

PCB Information	Name:DFR0848[V3.0.0]	Thickness: 1.6mm
Engineer:Roker	Top SolderMask: Black	Bottom SolderMask: Black
Date:20220815	Top Silkscreen: White	Bottom Silkscreen: White

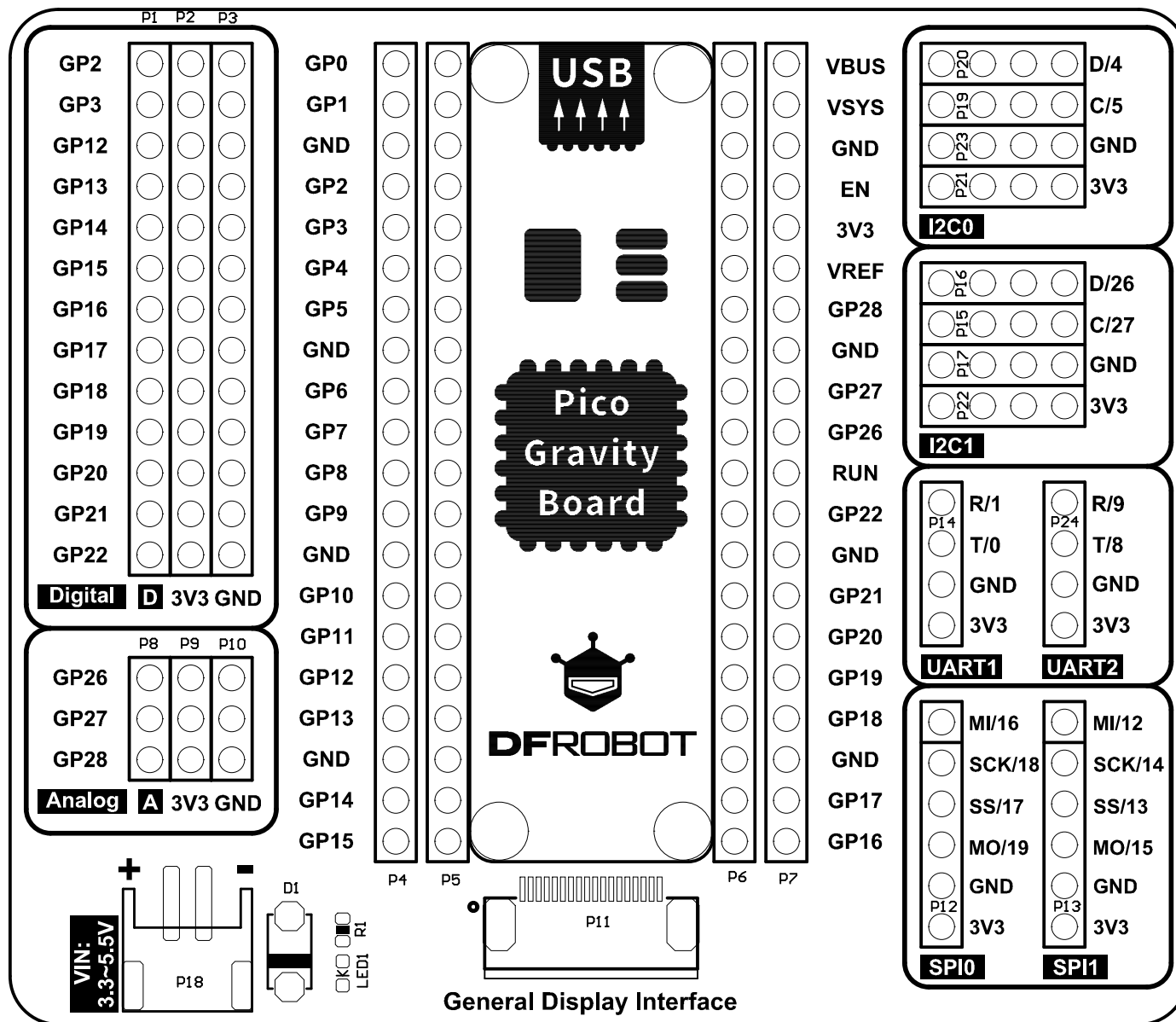

PCB Information	Name:DFR0848[V3.0.0]	Thickness: 1.6mm
Engineer:Roker	Top SolderMask: Black	Bottom SolderMask: Black
Date:20220815	Top Silkscreen: White	Bottom Silkscreen: White

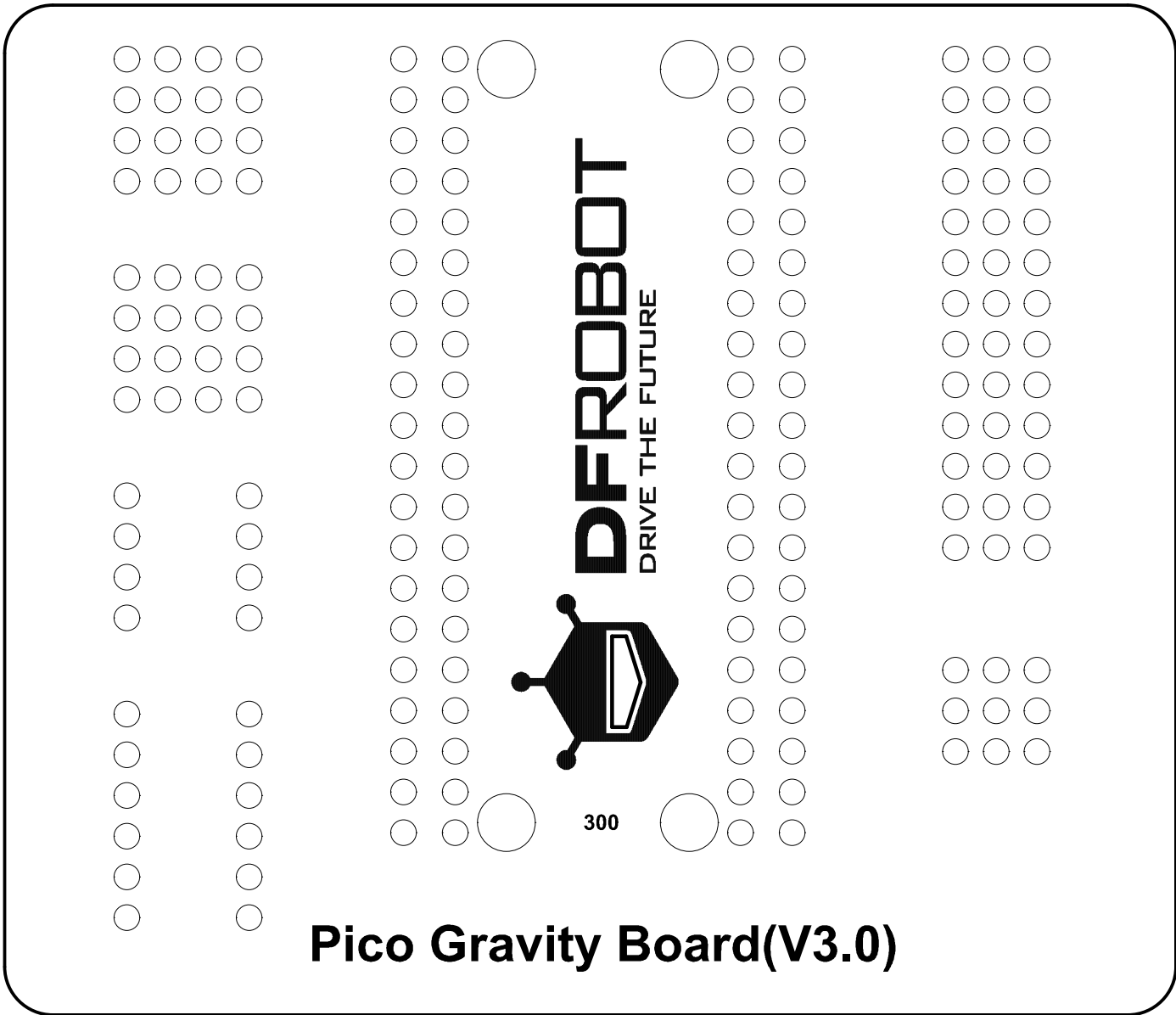

Pico Gravity Board(V3.0)

PCB Information	Name:DFR0848[V3.0.0]	Thickness: 1.6mm
Engineer:Roker	Top SolderMask: Black	Bottom SolderMask: Black
Date:20220815	Top Silkscreen: White	Bottom Silkscreen: White

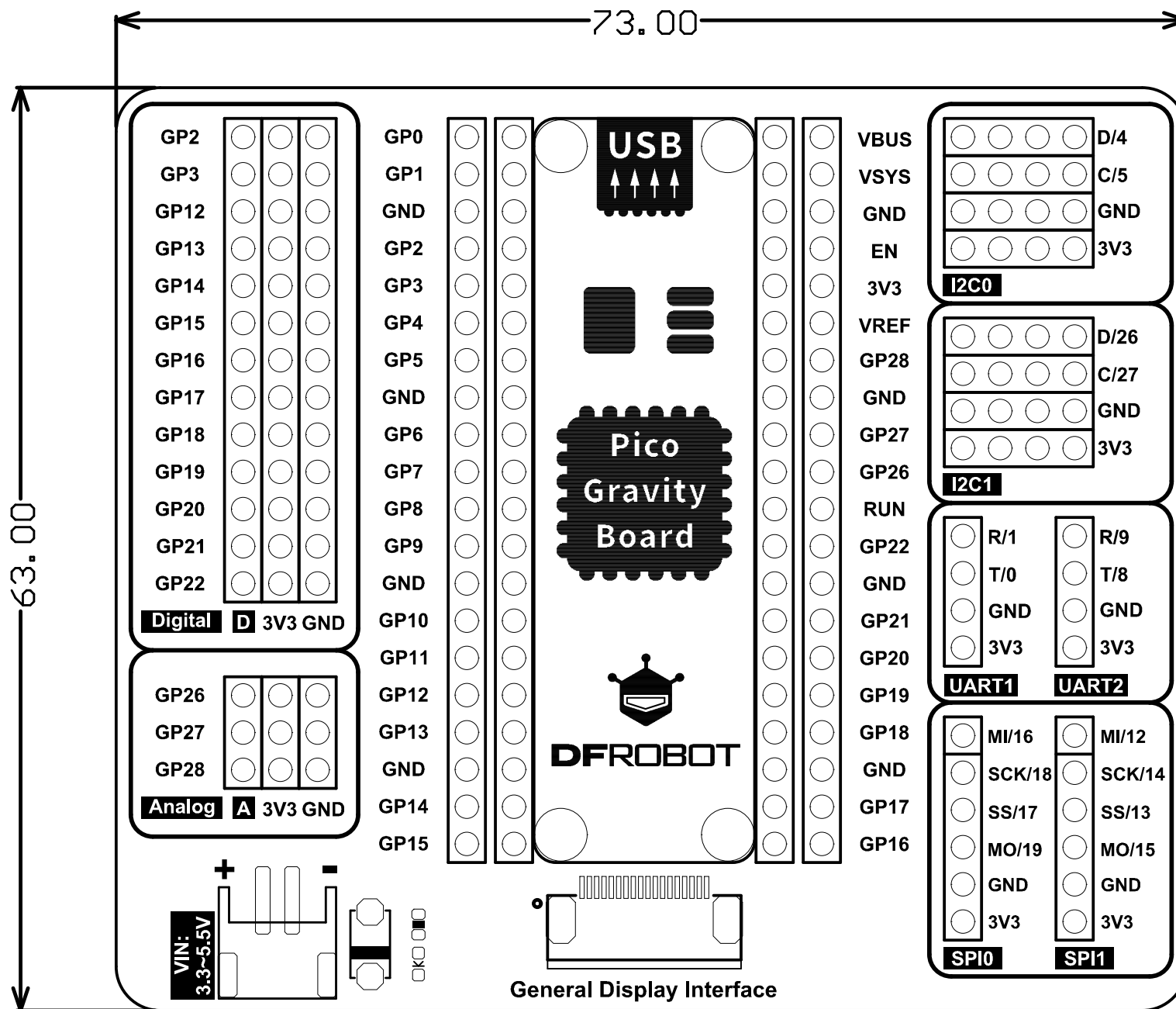

PCB Information	Name:DFR0848[V3.0.0]	Thickness: 1.6mm
Engineer:Roker	Top SolderMask: Black	Bottom SolderMask: Black
Date:20220815	Top Silkscreen: White	Bottom Silkscreen: White

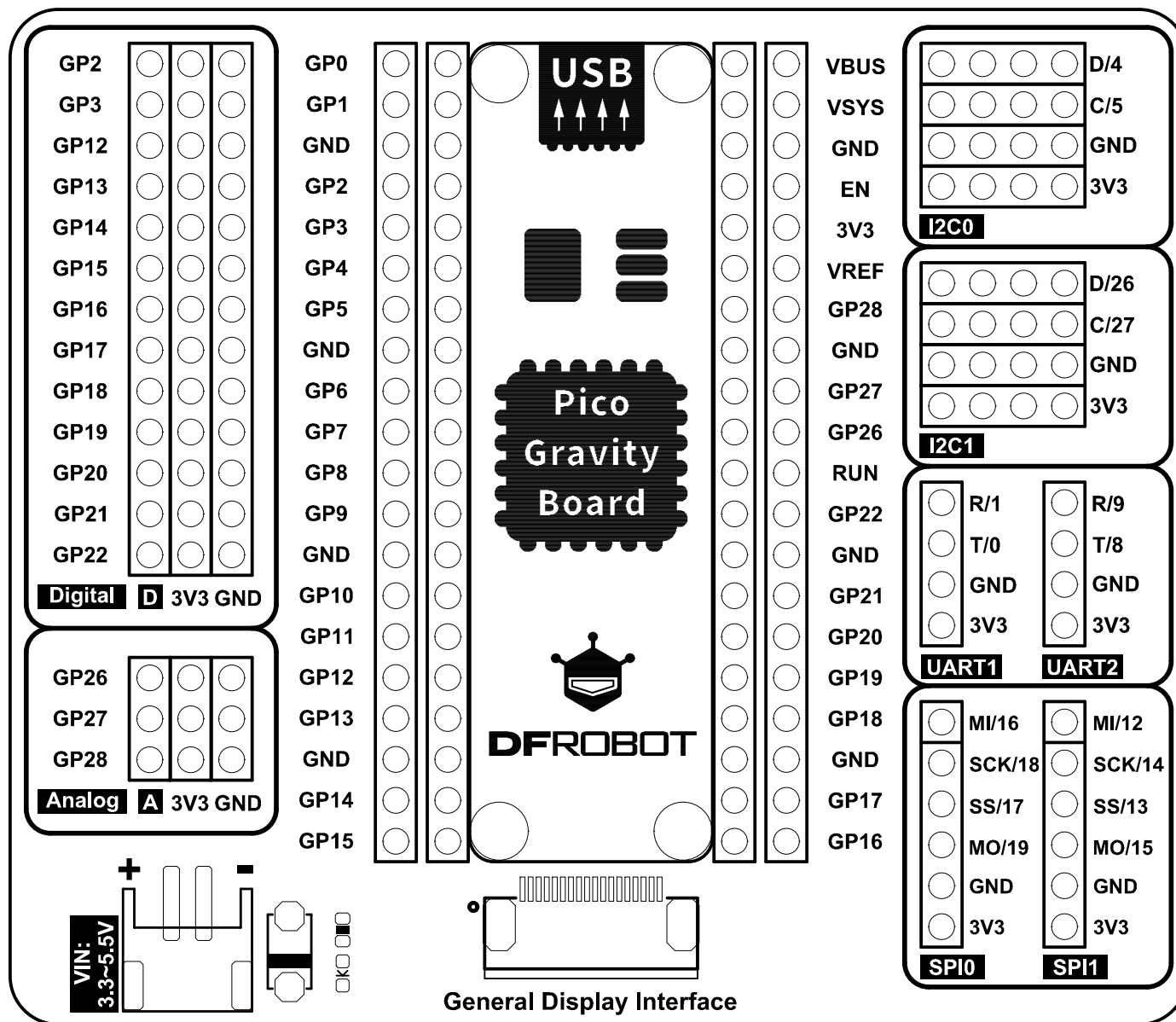

PCB Information	Name:DFR0848[V3.0.0]	Thickness: 1.6mm
Engineer:Roker	Top SolderMask: Black	Bottom SolderMask: Black
Date:20220815	Top Silkscreen: White	Bottom Silkscreen: White

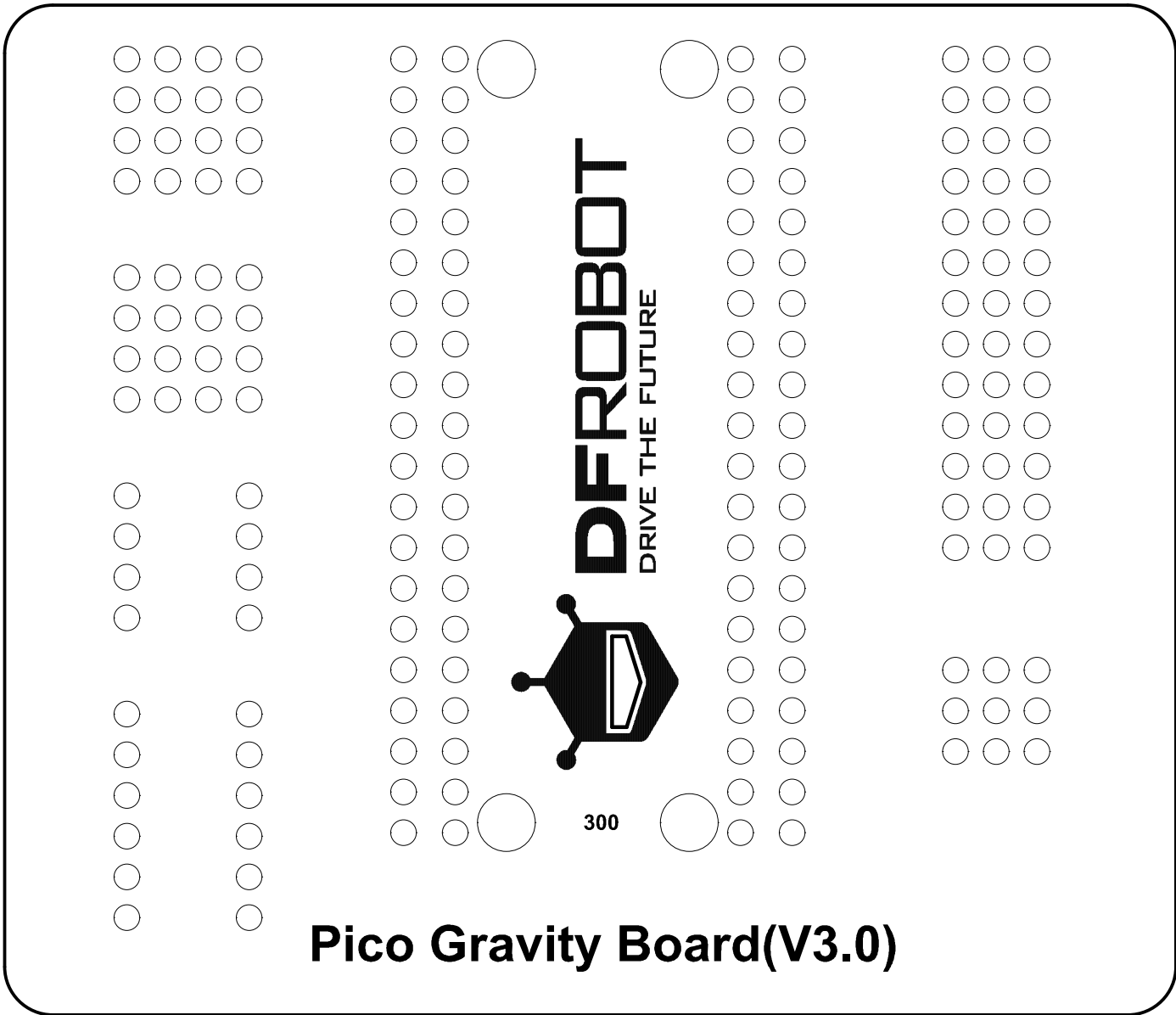

Pico Gravity Board(V3.0)

PCB Information	Name:DFR0848[V3.0.0]	Thickness: 1.6mm
Engineer:Roker	Top SolderMask: Black	Bottom SolderMask: Black
Date:20220815	Top Silkscreen: White	Bottom Silkscreen: White