

Title: Gravity BMX160+BMP388 10 DOF	SKU: SEN0252
Drawn: Aaron-CD	Revision: V1.0
Page: 1 of 1	Date: 2019/7/2
	Time: 13:11:02

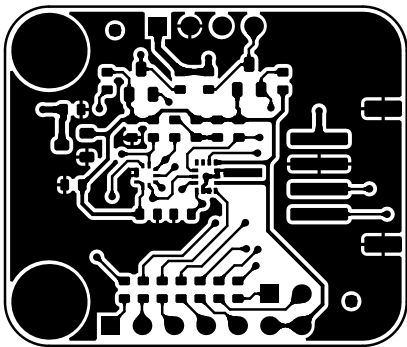

PCB Information	Name:SEN0252(V1.0)	Thickness: 1.6mm
Engineer:Aaron	Top SolderMask: Black	Bottom SolderMask: Black
Date: 20190701	Top Silkscreen: White	Bottom Silkscreen: White

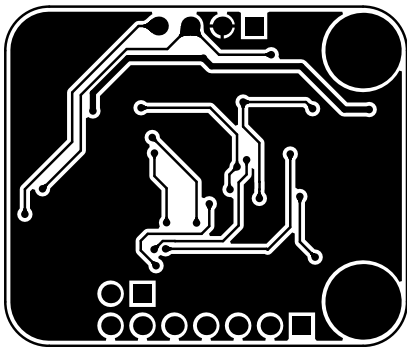

PCB Information	Name:SEN0252(V1.0)	Thickness: 1.6mm
Engineer:Aaron	Top SolderMask: Black	Bottom SolderMask: Black
Date: 20190701	Top Silkscreen: White	Bottom Silkscreen: White

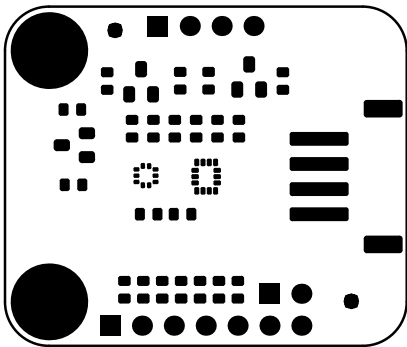
**PCB Information**

Name:SEN0252(V1.0)

Thickness: 1.6mm

Engineer:Aaron

Top SolderMask: Black

Bottom SolderMask: Black

Date: 20190701

Top Silkscreen: White

Bottom Silkscreen: White

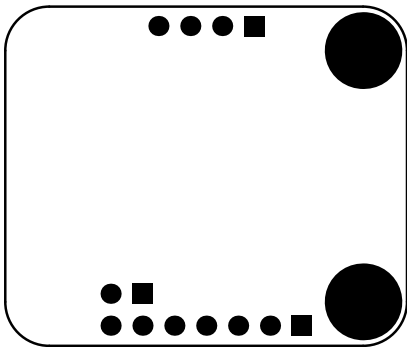

PCB Information		
Engineer: Aaron	Name: SEND252(V1.0)	Thickness: 1.6mm
Date: 20190701	Top SolderMask: Black	Bottom SolderMask: Black
	Top Silkscreen: White	Bottom Silkscreen: White

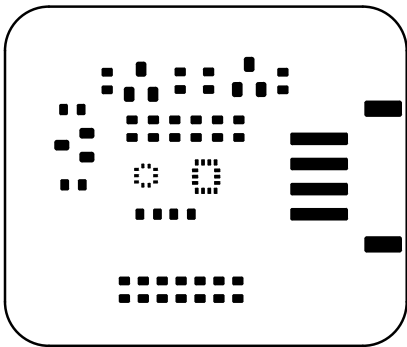

PCB Information	Name:SEN0252(V1.0)	Thickness: 1.6mm
Engineer:Aaron	Top SolderMask: Black	Bottom SolderMask: Black
Date: 20190701	Top Silkscreen: White	Bottom Silkscreen: White

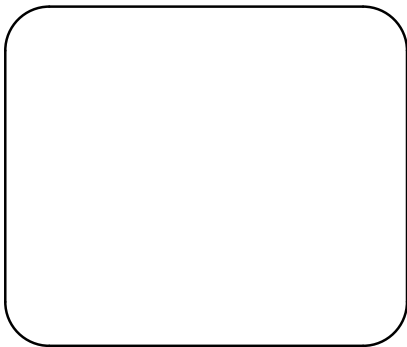

PCB Information	Name: SEND252(V1.0)	Thickness: 1.6mm
Engineer: Aaron	Top SolderMask: Black	Bottom SolderMask: Black
Date: 20190701	Top Silkscreen: White	Bottom Silkscreen: White

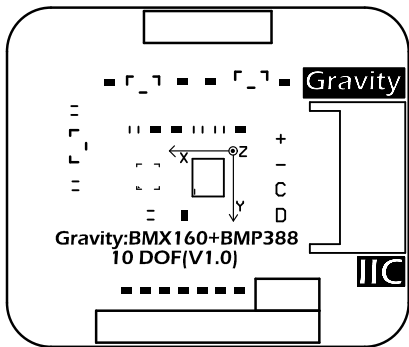

PCB Information

Name:SEN0252(V1.0)

Thickness: 1.6mm

Engineer:Aaron

Top SolderMask: Black

Bottom SolderMask: Black

Date: 20190701

Top Silkscreen: White

Bottom Silkscreen: White



SDA
SCL
GND
VCC

DFROBOT

ADDR<BMP388>
ADDR<BMX160>

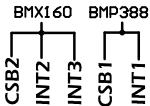

3V3



PCB Information

Name:SEN0252(V1.0)

Thickness: 1.6mm

Engineer:Aaron

Top SolderMask: Black

Bottom SolderMask: Black

Date: 20190701

Top Silkscreen: White

Bottom Silkscreen: White

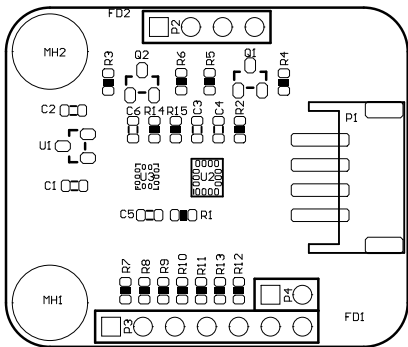

PCB Information

Engineer: Aaron

Date: 20190701

Name: SEN0252(V1.0)

Top SolderMask: Black

Top Silkscreen: White

Thickness: 1.6mm

Bottom SolderMask: Black

Bottom Silkscreen: White

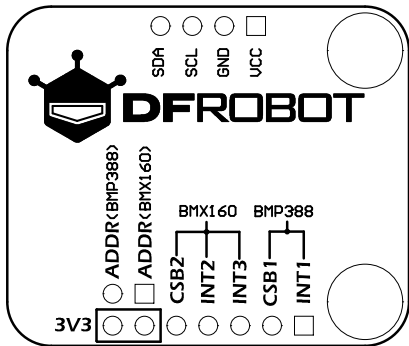

PCB Information

Name:SEN0252(V1.0)

Thickness: 1.6mm

Engineer:Aaron

Top SolderMask: Black

Bottom SolderMask: Black

Date: 20190701

Top Silkscreen: White

Bottom Silkscreen: White

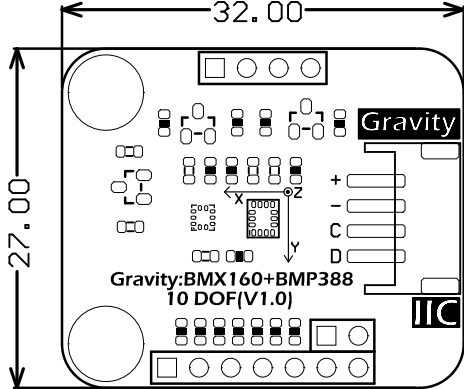

PCB Information	Name:SEN0252(V1.0)	Thickness: 1.6mm
Engineer:Aaron	Top SolderMask: Black	Bottom SolderMask: Black
Date: 20190701	Top Silkscreen: White	Bottom Silkscreen: White

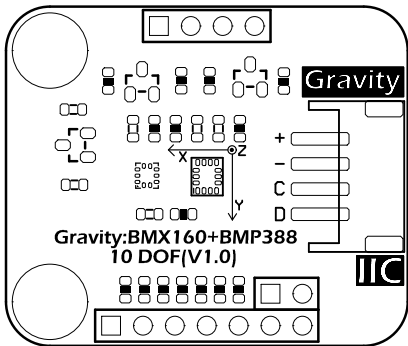

PCB Information

Name:SEN0252(V1.0)

Thickness: 1.6mm

Engineer:Aaron

Top SolderMask: Black

Bottom SolderMask: Black

Date: 20190701

Top Silkscreen: White

Bottom Silkscreen: White

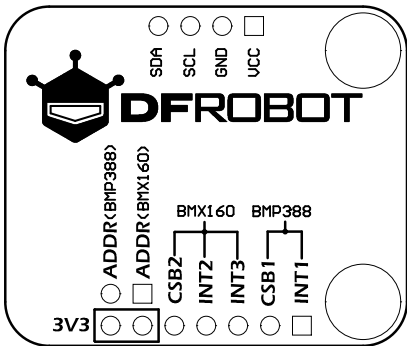

PCB Information

Name:SEN0252(V1.0)

Thickness: 1.6mm

Engineer:Aaron

Top SolderMask: Black

Bottom SolderMask: Black

Date: 20190701

Top Silkscreen: White

Bottom Silkscreen: White