

PCB Information Top_Layer 2026-02-05
SEN0695-V1.0.0-1.6mm-2 Layer-24*18mmmm
Top SolderMask:Black Bottom SolderMask:Black
Top Silkscreen:White Bottom Silkscreen:White

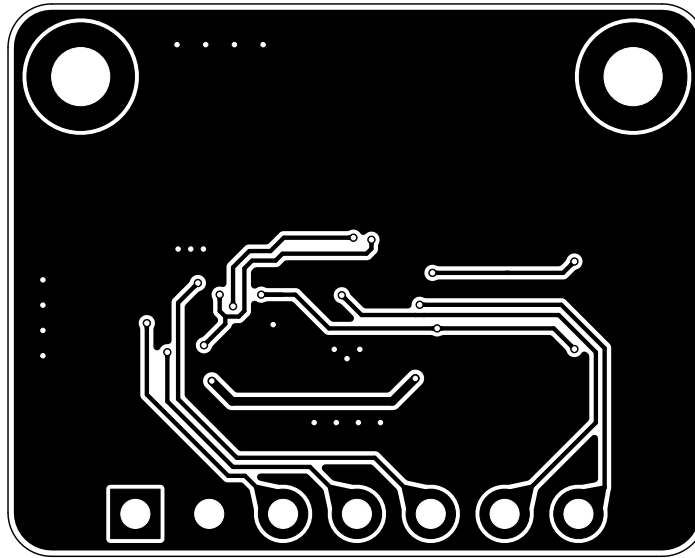

PCB Information Bottom_Layer 2026-02-05
SEN0695-V1.0.0-1.6mm-2 Layer-24*18mmmm
Top SolderMask:Black Bottom SolderMask:Black
Top Silkscreen:White Bottom Silkscreen:White

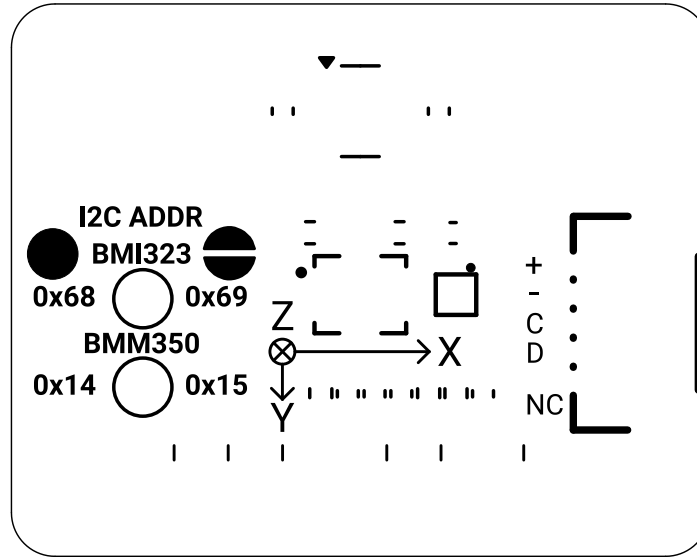

PCB Information Top_Silkscreen 2026-02-05
 SEN0695-V1.0.0-1.6mm-2 Layer-24*18mmmm
 Top SolderMask:Black Bottom SolderMask:Black
 Top Silkscreen:White Bottom Silkscreen:White



PCB Information Bottom_Silkscreen 2026-02-05
SEN0695-V1.0.0-1.6mm-2 Layer-24*18mmmm
Top SolderMask:Black Bottom SolderMask:Black
Top Silkscreen:White Bottom Silkscreen:White

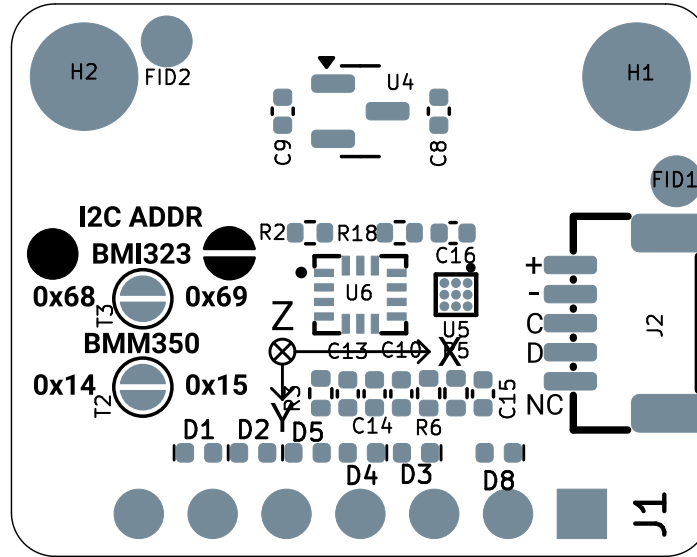

PCB Information Top_Location 2026-02-05
 SEN0695-V1.0.0-1.6mm-2 Layer-24*18mmmm
 Top SolderMask:Black Bottom SolderMask:Black
 Top Silkscreen:White Bottom Silkscreen:White

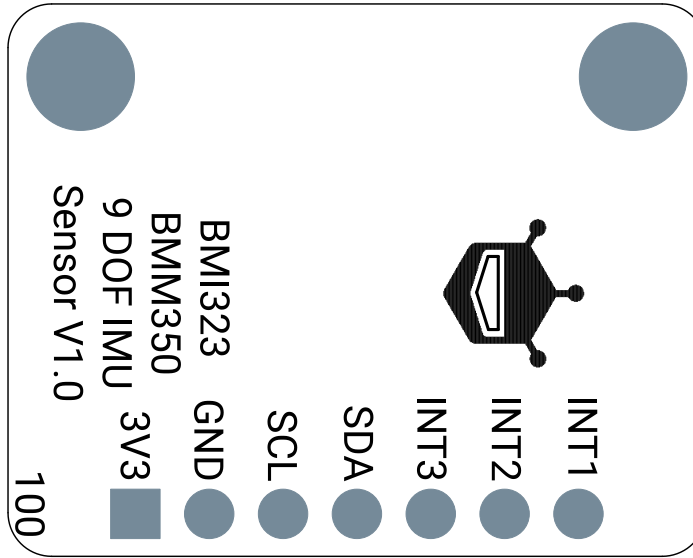

PCB Information Bottom_Location 2026-02-05
SEN0695-V1.0.0-1.6mm-2 Layer-24*18mmmm
Top SolderMask:Black Bottom SolderMask:Black
Top Silkscreen:White Bottom Silkscreen:White

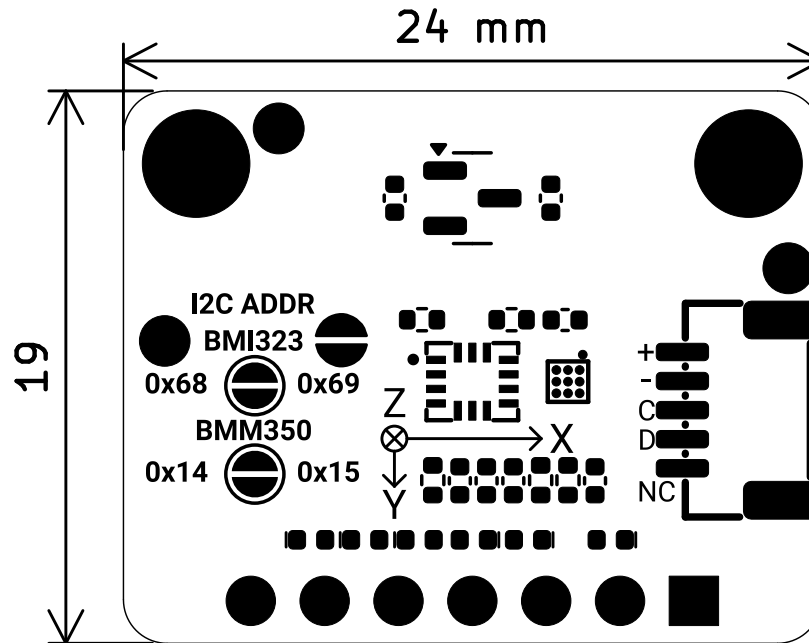

PCB Information Board_Size 2026-02-05
 SEN0695-V1.0.0-1.6mm-2 Layer-24*18mmmm
 Top SolderMask:Black Bottom SolderMask:Black
 Top Silkscreen:White Bottom Silkscreen:White

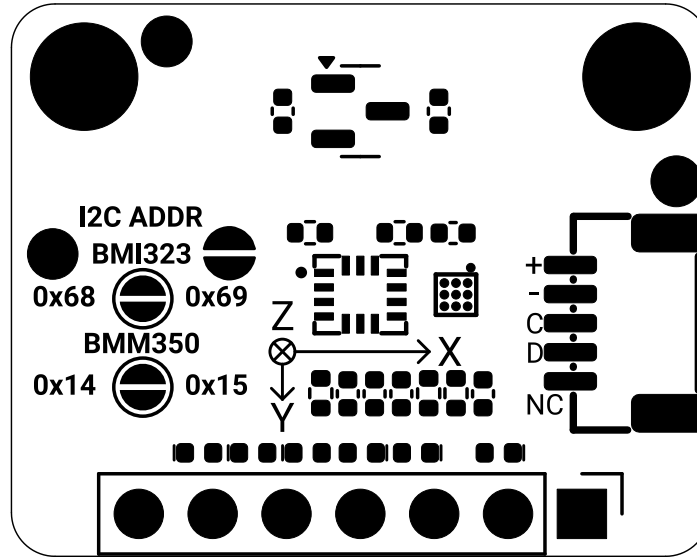

PCB Information Top_Testpoint 2026-02-05
SEN0695-V1.0.0-1.6mm-2 Layer-24*18mmmm
Top SolderMask:Black Bottom SolderMask:Black
Top Silkscreen:White Bottom Silkscreen:White

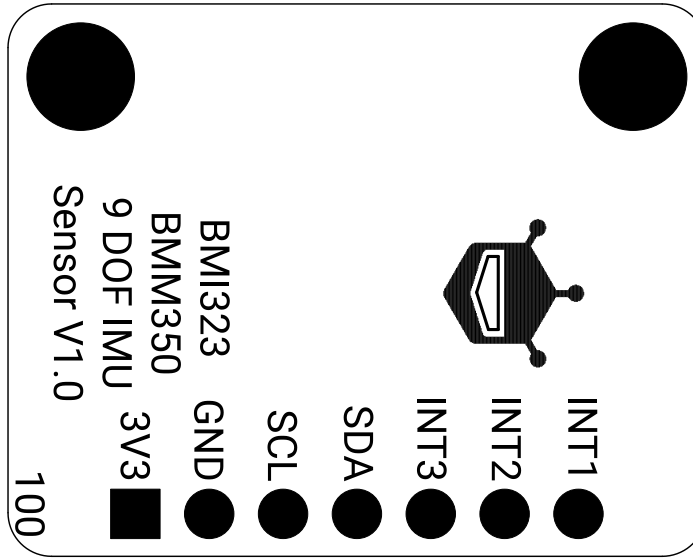

PCB Information Bottom_Testpoint 2026-02-05
SEN0695-V1.0.0-1.6mm-2 Layer-24*18mmmm
Top SolderMask:Black Bottom SolderMask:Black
Top Silkscreen:White Bottom Silkscreen:White

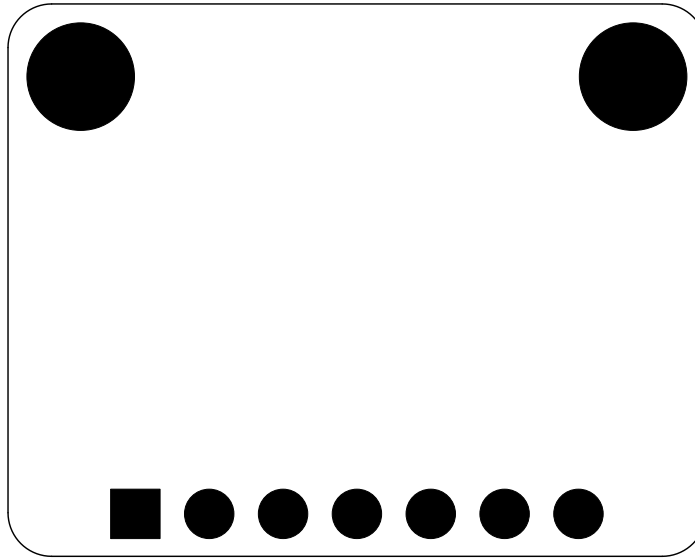

PCB Information Bottom_Musk 2026-02-05
SEN0695-V1.0.0-1.6mm-2 Layer-24*18mmmm
Top SolderMask:Black Bottom SolderMask:Black
Top Silkscreen:White Bottom Silkscreen:White

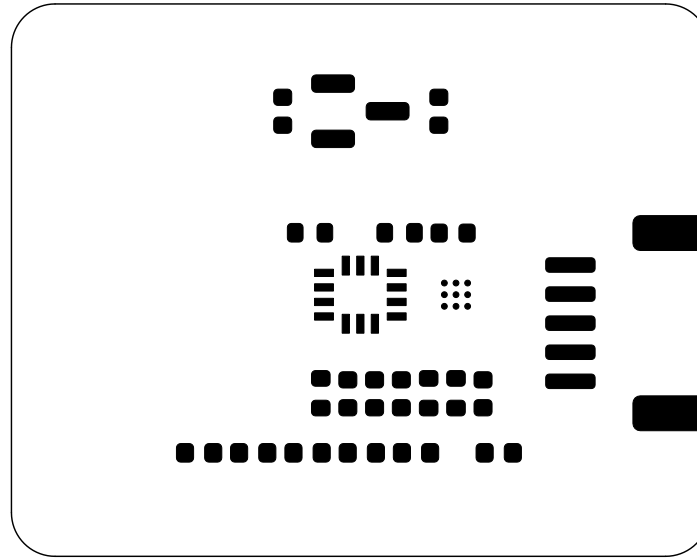

PCB Information Top_Paste 2026-02-05
SEN0695-V1.0.0-1.6mm-2 Layer-24*18mmmm
Top SolderMask:Black Bottom SolderMask:Black
Top Silkscreen:White Bottom Silkscreen:White

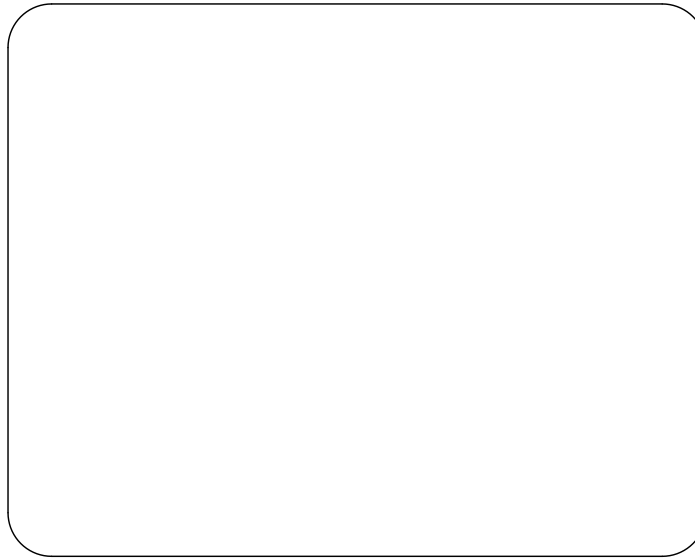

PCB Information Bottom_Paste 2026-02-05
SEN0695-V1.0.0-1.6mm-2 Layer-24*18mmmm
Top SolderMask:Black Bottom SolderMask:Black
Top Silkscreen:White Bottom Silkscreen:White