

PCB Information Top\_Layer 2026-02-05  
SEN0693-V1.0.0-1.0mm-2 Layer-16\*16mmmm  
Top SolderMask:Black Bottom SolderMask:Black  
Top Silkscreen:White Bottom Silkscreen:White

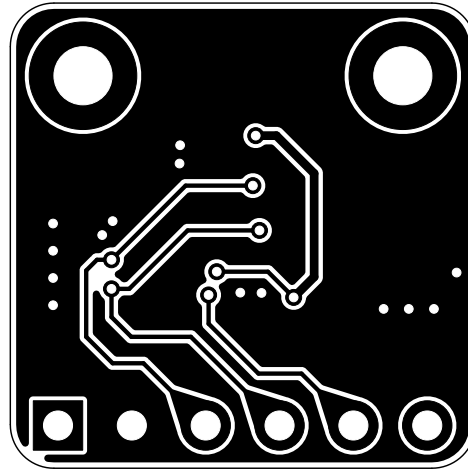

PCB Information Bottom\_Layer 2026-02-05  
SEN0693-V1.0.0-1.0mm-2 Layer-16\*16mmmm  
Top SolderMask:Black Bottom SolderMask:Black  
Top Silkscreen:White Bottom Silkscreen:White

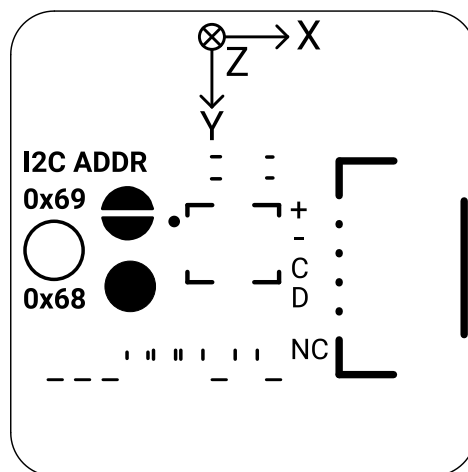

PCB Information Top\_Silkscreen 2026-02-05  
 SEN0693-V1.0.0-1.0mm-2 Layer-16\*16mmmm  
 Top SolderMask:Black Bottom SolderMask:Black  
 Top Silkscreen:White Bottom Silkscreen:White

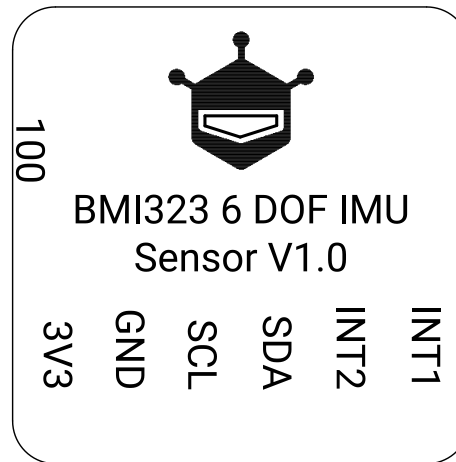

PCB Information Bottom\_Silkscreen 2026-02-05  
SEN0693-V1.0.0-1.0mm-2 Layer-16\*16mmmm  
Top SolderMask:Black Bottom SolderMask:Black  
Top Silkscreen:White Bottom Silkscreen:White

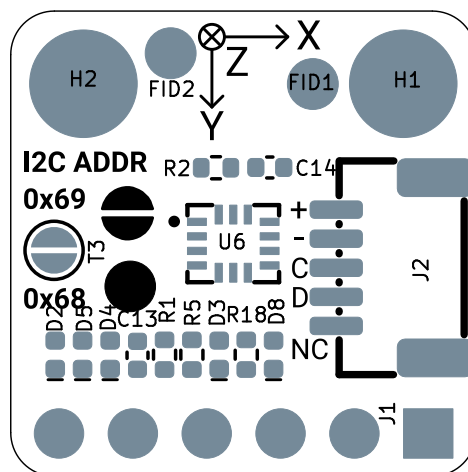

PCB Information Top\_Location 2026-02-05  
 SEN0693-V1.0.0-1.0mm-2 Layer-16\*16mmmm  
 Top SolderMask:Black Bottom SolderMask:Black  
 Top Silkscreen:White Bottom Silkscreen:White

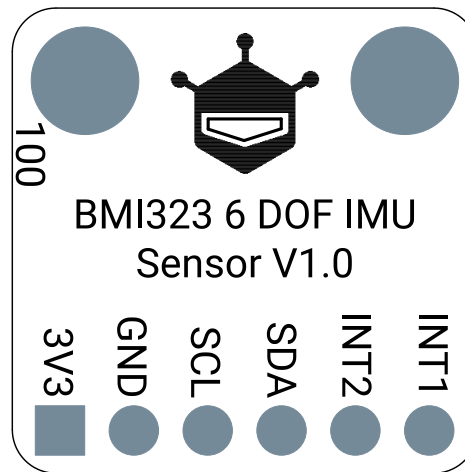

PCB Information Bottom\_Location 2026-02-05  
SEN0693-V1.0.0-1.0mm-2 Layer-16\*16mmmm  
Top SolderMask:Black Bottom SolderMask:Black  
Top Silkscreen:White Bottom Silkscreen:White

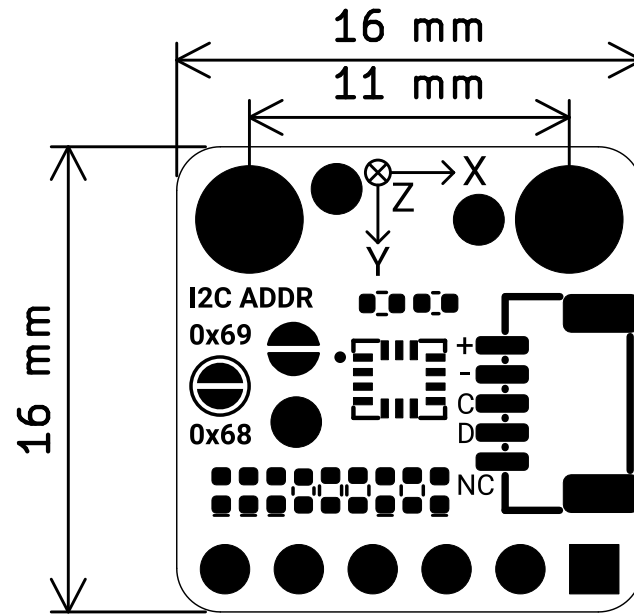

PCB Information Board\_Size 2026-02-05

SEN0693-V1.0.0-1.0mm-2 Layer-16\*16mmmm

Top SolderMask:Black Bottom SolderMask:Black

Top Silkscreen:White Bottom Silkscreen:White

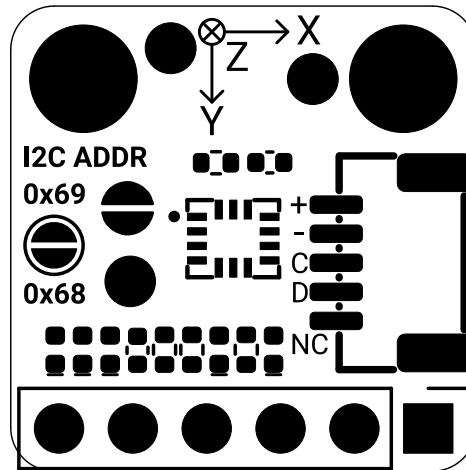

PCB Information Top\_Testpoint 2026-02-05  
SEN0693-V1.0.0-1.0mm-2 Layer-16\*16mmmm  
Top SolderMask:Black Bottom SolderMask:Black  
Top Silkscreen:White Bottom Silkscreen:White

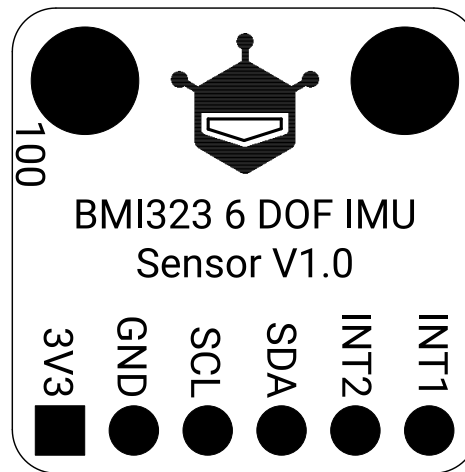

PCB Information Bottom\_Testpoint 2026-02-05  
SEN0693-V1.0.0-1.0mm-2 Layer-16\*16mmmm  
Top SolderMask:Black Bottom SolderMask:Black  
Top Silkscreen:White Bottom Silkscreen:White

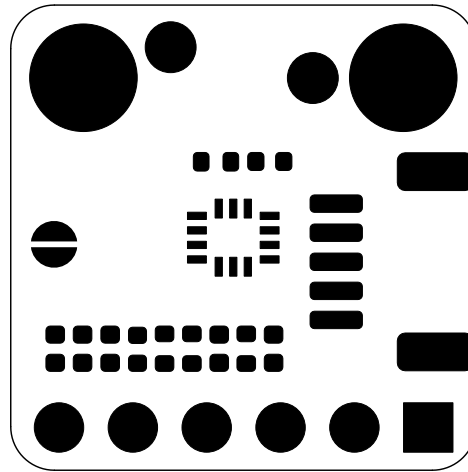

PCB Information Top\_Musk 2026-02-05  
SEN0693-V1.0.0-1.0mm-2 Layer-16\*16mmmm  
Top SolderMask:Black Bottom SolderMask:Black  
Top Silkscreen:White Bottom Silkscreen:White

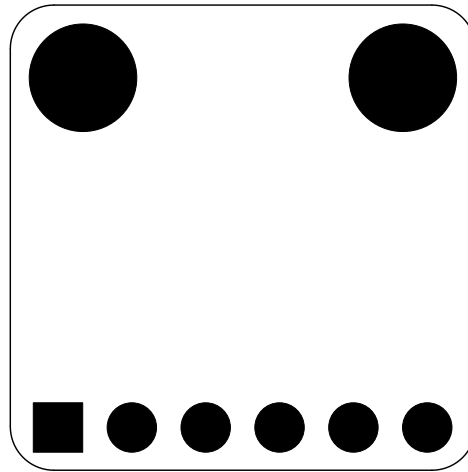

PCB Information Bottom\_Musk 2026-02-05  
SEN0693-V1.0.0-1.0mm-2 Layer-16\*16mmmm  
Top SolderMask:Black Bottom SolderMask:Black  
Top Silkscreen:White Bottom Silkscreen:White

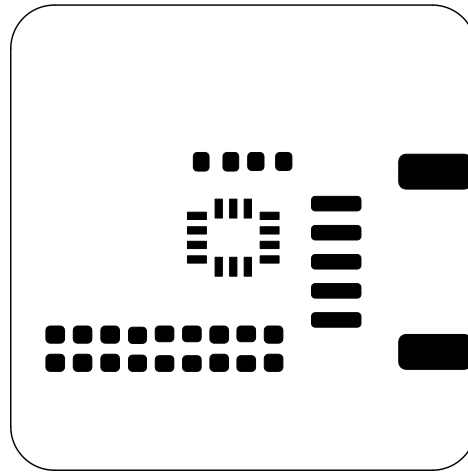

PCB Information Top\_Paste 2026-02-05

SEN0693-V1.0.0-1.0mm-2 Layer-16\*16mmmm

Top SolderMask:Black Bottom SolderMask:Black

Top Silkscreen:White Bottom Silkscreen:White

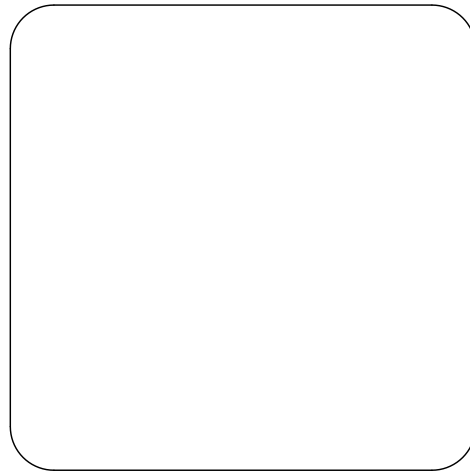

PCB Information Bottom\_Paste 2026-02-05  
SEN0693-V1.0.0-1.0mm-2 Layer-16\*16mmmm  
Top SolderMask:Black Bottom SolderMask:Black  
Top Silkscreen:White Bottom Silkscreen:White